

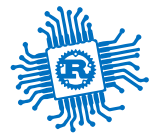

Introduction into PM

Lecture 1



Welcome

to the *Proiectarea cu Microprocesoare* engineering class

You will learn

- how hardware works
- how to actually build your own hardware device
- the Rust programming Language
- a little bit of low level C

We expect

- to come to class
- ask a lot of questions
- maybe some work at home

2025 is an experiment - we will keep it chill



DISCLAIMER

- These slides represent a summary.
- The slides do not cover all the explanations, simulations, or demonstrations provided during the course.
- The slides do not limit, in any way, the material required for the exam.
- For the complete version, you are welcome to attend the course.

(copyright info) These slides may contain materials shared with my colleagues Alexandru Radovici, Dan Tudose, Alexandru Vaduva, Razvan Tataroiu

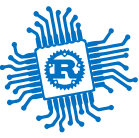

ENG

Scientific understanding of the natural world

Used to invent, design, and build things

Used to solve problems and achieve practical goal

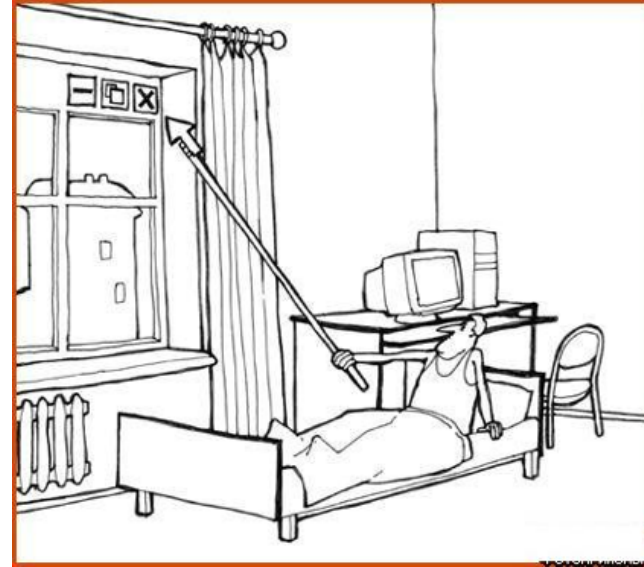

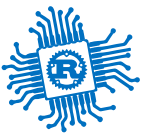

Abstract level

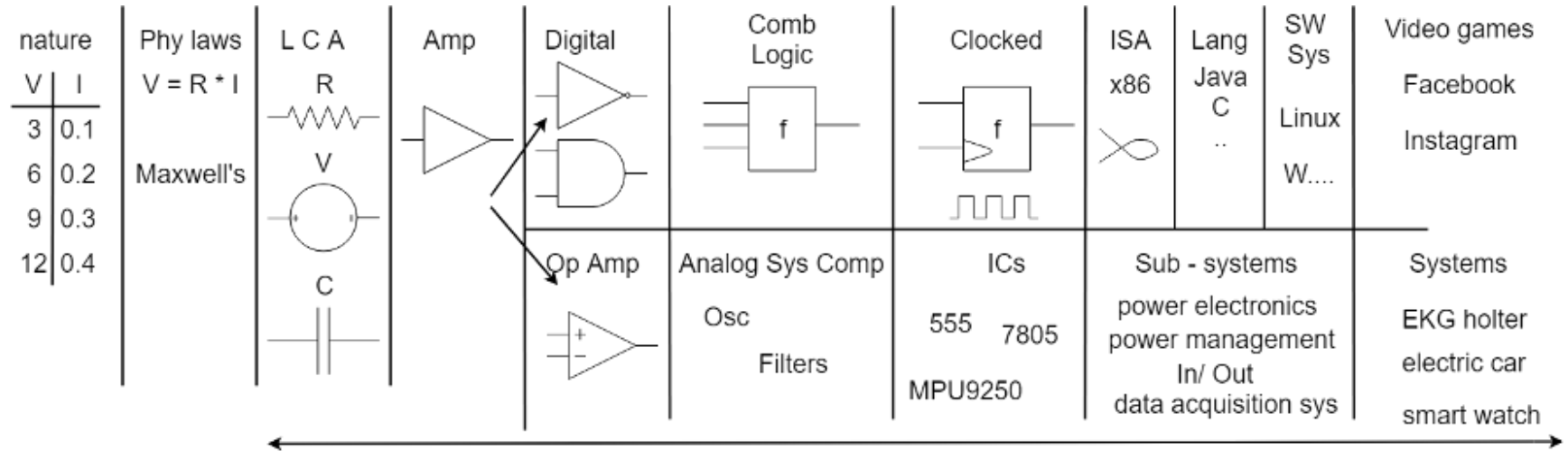

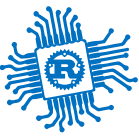

Why PM

Computing systems with microprocessors > everywhere

Questions for an engineer:

- What is inside a computing system?
- How do the components interact?
- How do I design a system that interacts with the physical environment?
- How do I choose the best hardware option for an embedded system?

"Data-based decisions" – based on IoT infrastructure require:

- Actual physical sensors
- Lots of IoT custom hardware

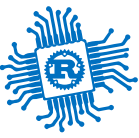

Team



Our team

Daniel Rosner



Course Professor

Irina Niță



Lab Professor
Software

Irina Bradu



Lab Professor

Teodor Dicu



Lab Professor
Hardware

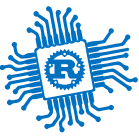

Despre Daniel Rosner

Cursuri

DEEA

PM

How To Build Your Cyber Security
Startup

VZ & PoliFest

Innovation Labs &
Concursuri (tech)

Tech area

Automotive

MedTech

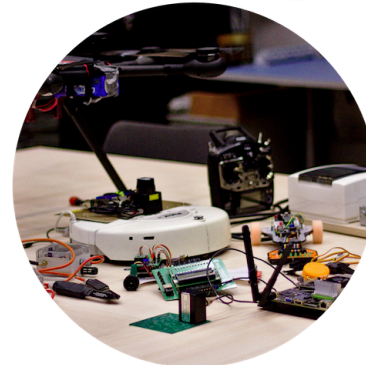
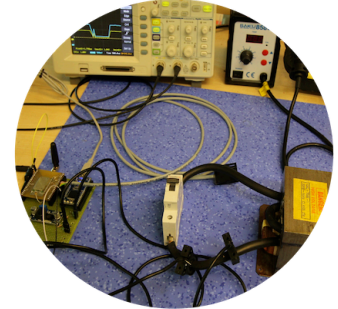

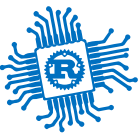

Outline



Outline

Lectures

- 12 lectures
- 1 Q&A lecture for the project

Labs

- 12 labs

Project

- Build a hardware device running software written in Rust or C on a microcontroller-based board
- The cost for the hardware is around 150 RON
- Presented at PM Fair during the last week of the semester

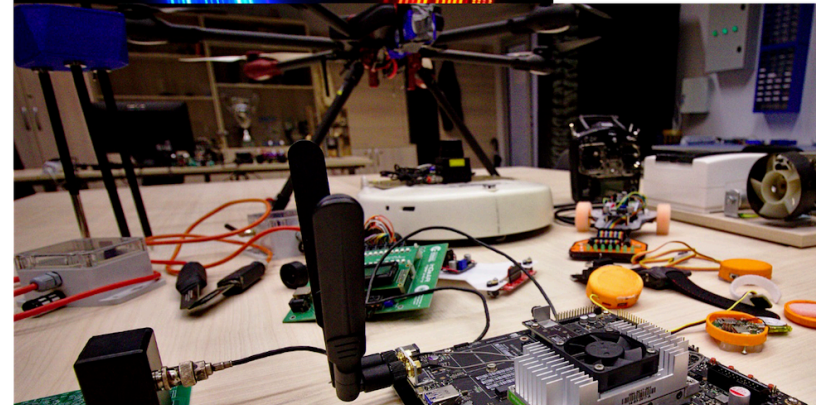
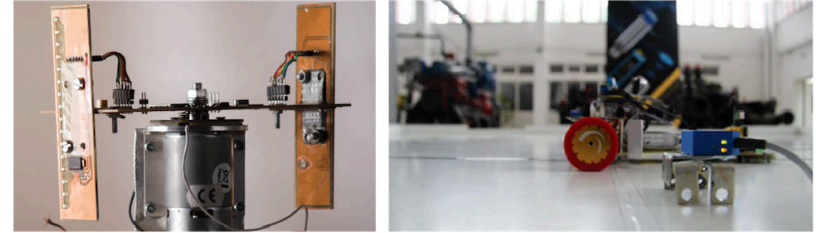

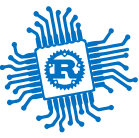

Scoring Structure

1 point for lab activity

1 point for lab assignment (final lab exam)

3 points PROJECT

2 points lectures activity (announced tests)

3 points @ Final Exam

Bo nus

+0.75 bonus for top 30 projects of the year (top 7%)

+0.75 bonus for top 10 projects of the year

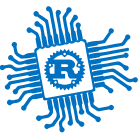

Project

Structure

Documentation / Hard / Soft

PM-fair

Project scope

Needs to be approved by your laboratory teacher

It can not be super-simple!

(digital clock, digital thermometer)

A few reference points:

It can not be simpler than one laboratory

It can not be based on a 30 min youtube tutorial

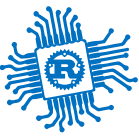

Extra

Bonus for competition & activity results

Up to 1 point for results in the top at technical profile competitions

Up to 0.5 bonus points for involvement in student volunteer activities

Email in pre-session with Subject: Bonus_PM FirstName_LastName_32xCC

Equivalencies

Up to 3 points for results at technical competitions:

- ACM (top 50%);
- Innovation Labs (SemiFinals);
- Suceava Hard and Soft (top 50%);

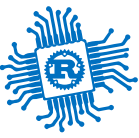

(Example) Innovation Labs

Why join:



CV



Team-Work



Professional Networking



Presentations skills



Build your own start-up with a super support structure



500.000 EURO Investment Prize



Summer Internship @ your own start-up



8 - 9 March - the largest, coolest, most fun Hackathon in Romania

PS: 🕒 Is it a good time considering how the IT market looks?

🎉 Yes! > It's the best time:

📝 gain practical experience & boost your CV;

🏢 build a public profile & establish 👤 relationships with IL partner IT companies (e.g., Adobe, Keysight, NXP, UiPath, Stripe);

🤖 improve your skills beyond coding (lowers the risk of being replaced by ChatGPT :))

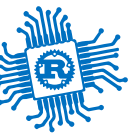

Apollo Guidance Computer

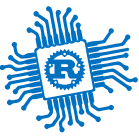

We choose to go to the moon

John F. Kennedy, Rice University, 1961

*in this decade and do the other things, **not because they are easy, but because they are hard**, because **that goal will serve to organize and measure the best of our energies and skills**, because that challenge is one that we are willing to accept, one we are unwilling to postpone, and one which we intend to win, and the others, too.*

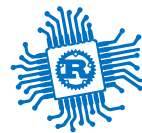

AGC

August 1966

Frequency	2.048 MHz
World Length	15 + 1 bit
RAM	4096 B
Storage	72 KB
Software API	AGC Assembly Language

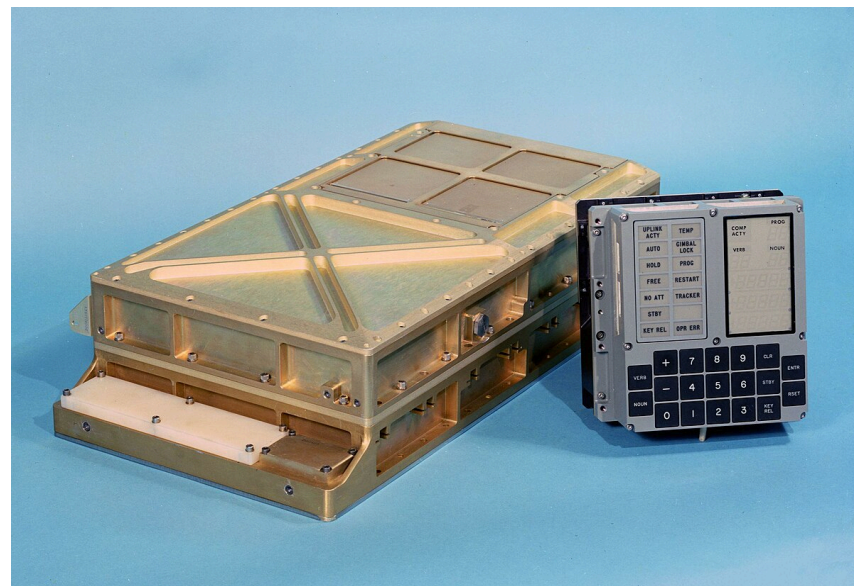

This landed the *moon eagle*.

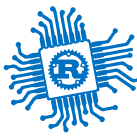

DSKY

Display and keyboard

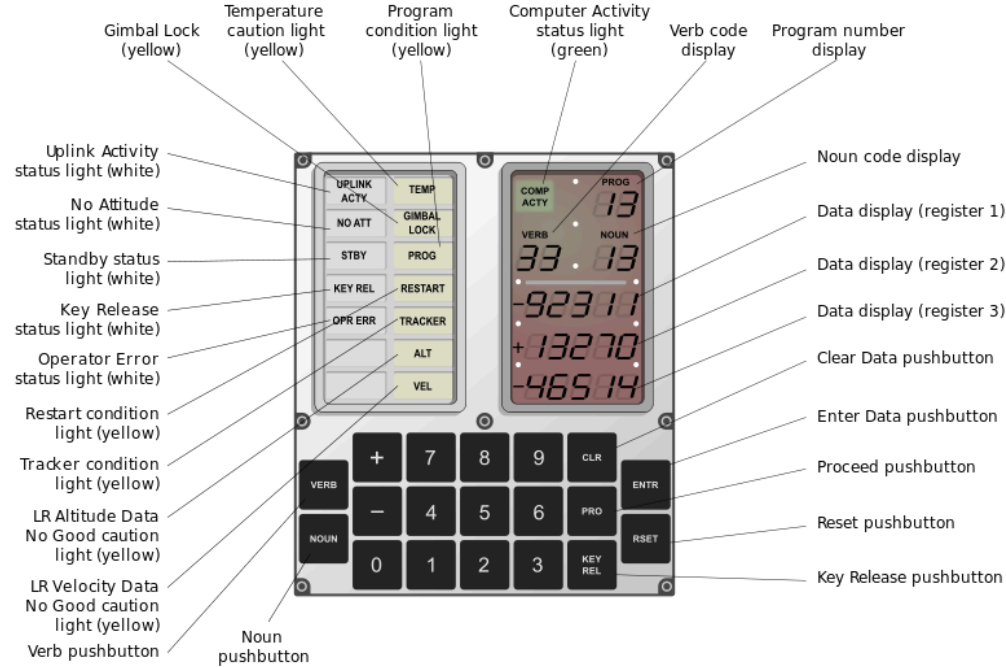

Simulator

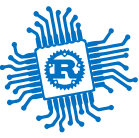

Where we are now



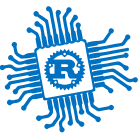

Embedded Systems

In general, they have a dedicated function.

Common constraints:

Real-time requirements

Fixed response time:

- Control (e.g., constant-time sampling)
- Safety (response within a limited time upon detection)

Limited resources (processing power/memory)

Robustness requirements (aka high uptime)

Example

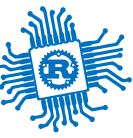

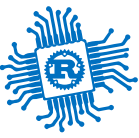

Example controller

NXP S32ZE

STM32H

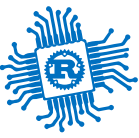

Example ENTy

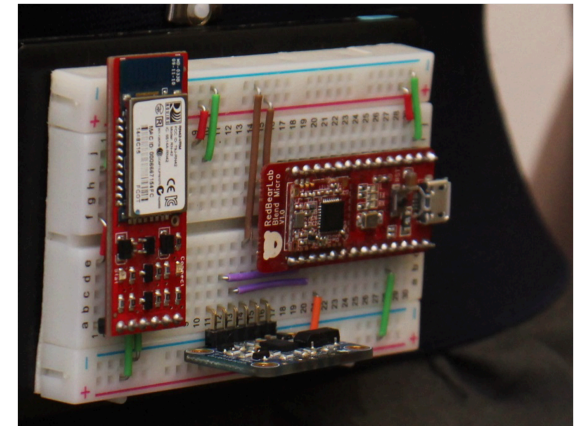
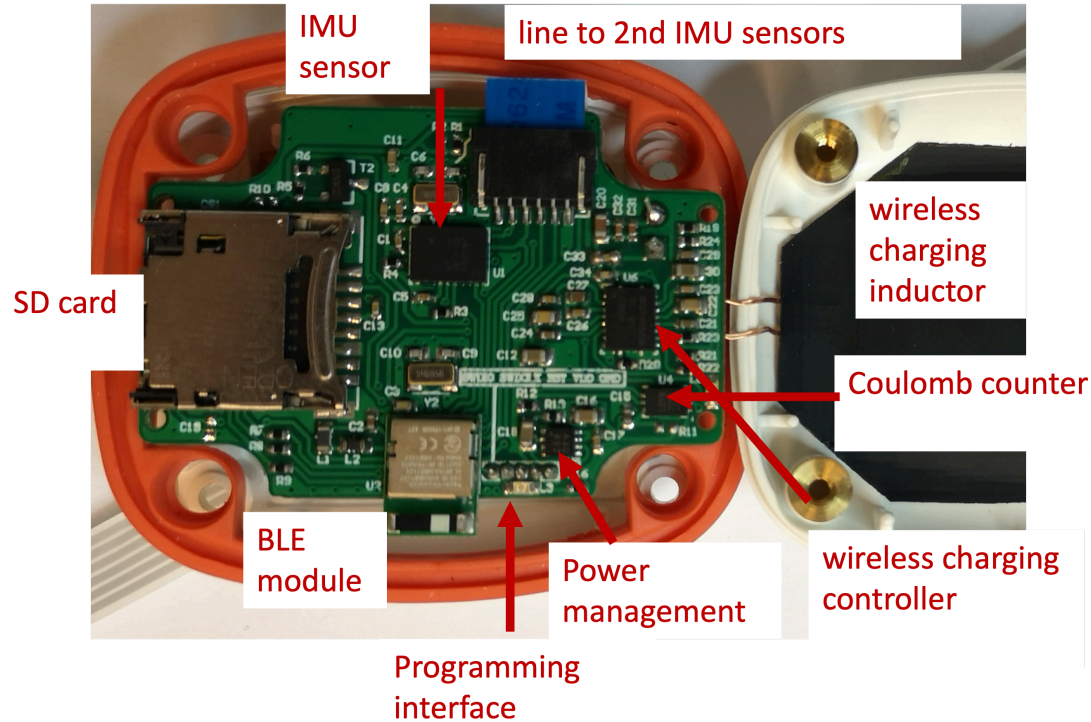

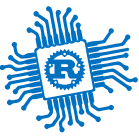

Example Companies

NXP

Infineon

Microchip

EPG

Renault

Continental

Viavi

Siemens

Emerson

GE

Honeywell

Thales

Hella

Bosch

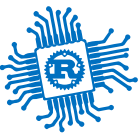

What is a microprocessor?



Microcontroller (MCU)

Integrated in embedded systems for certain tasks

- low operating frequency (MHz)
- a lot of I/O ports
- controls hardware
- does not require an Operating System
- costs \$0.1 - \$25
- annual demand is billions

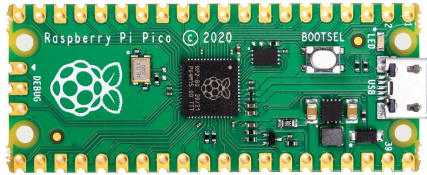

Microprocessor (CPU)

General purpose, for PC & workstations

- high operating frequency (GHz)
- limited number of I/O ports
- usually requires an Operating System
- costs \$75 - \$500
- annual demand is tens of millions

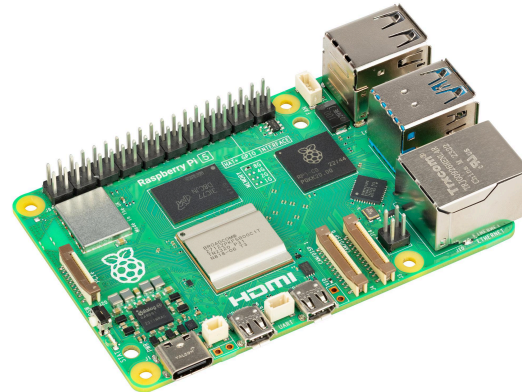

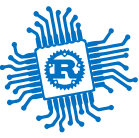

How a microprocessor works

This is a simple processor

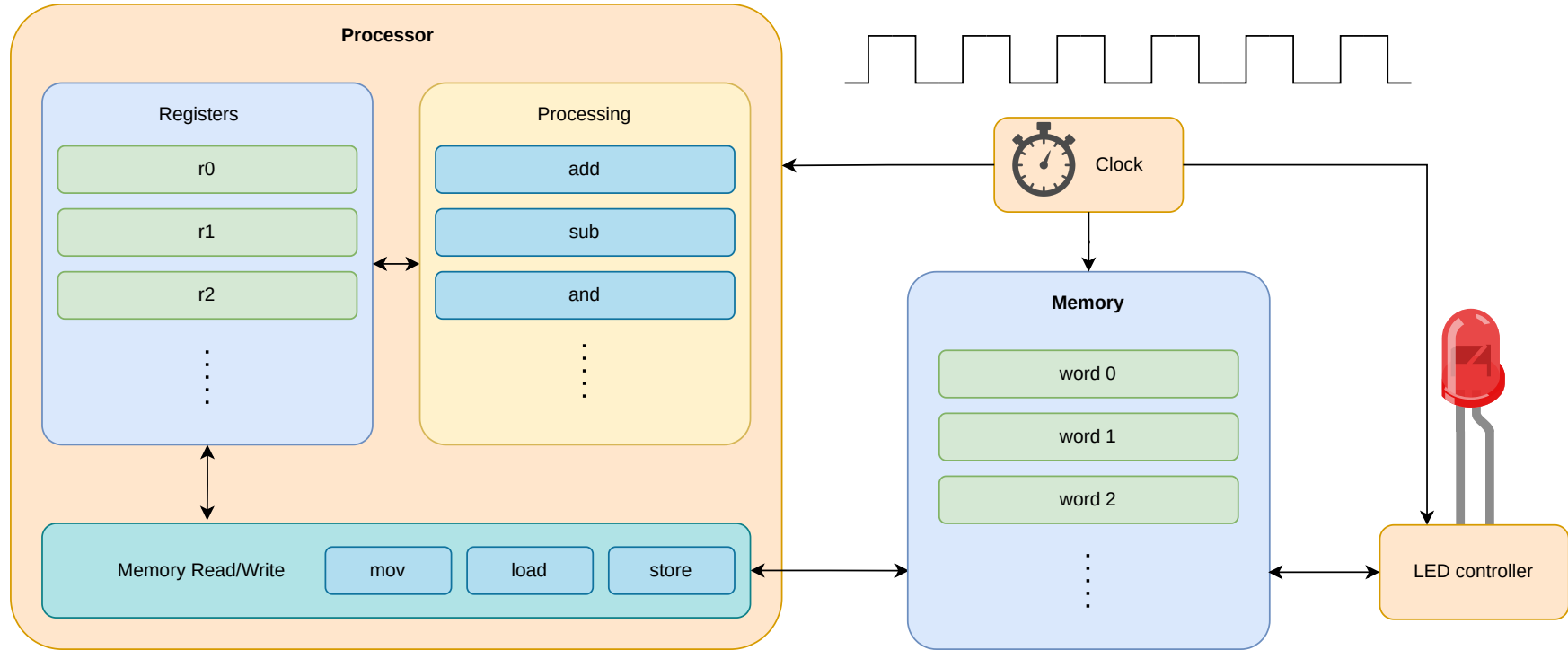

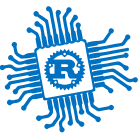

8 bit processor

a simple 8 bit processor with a text display

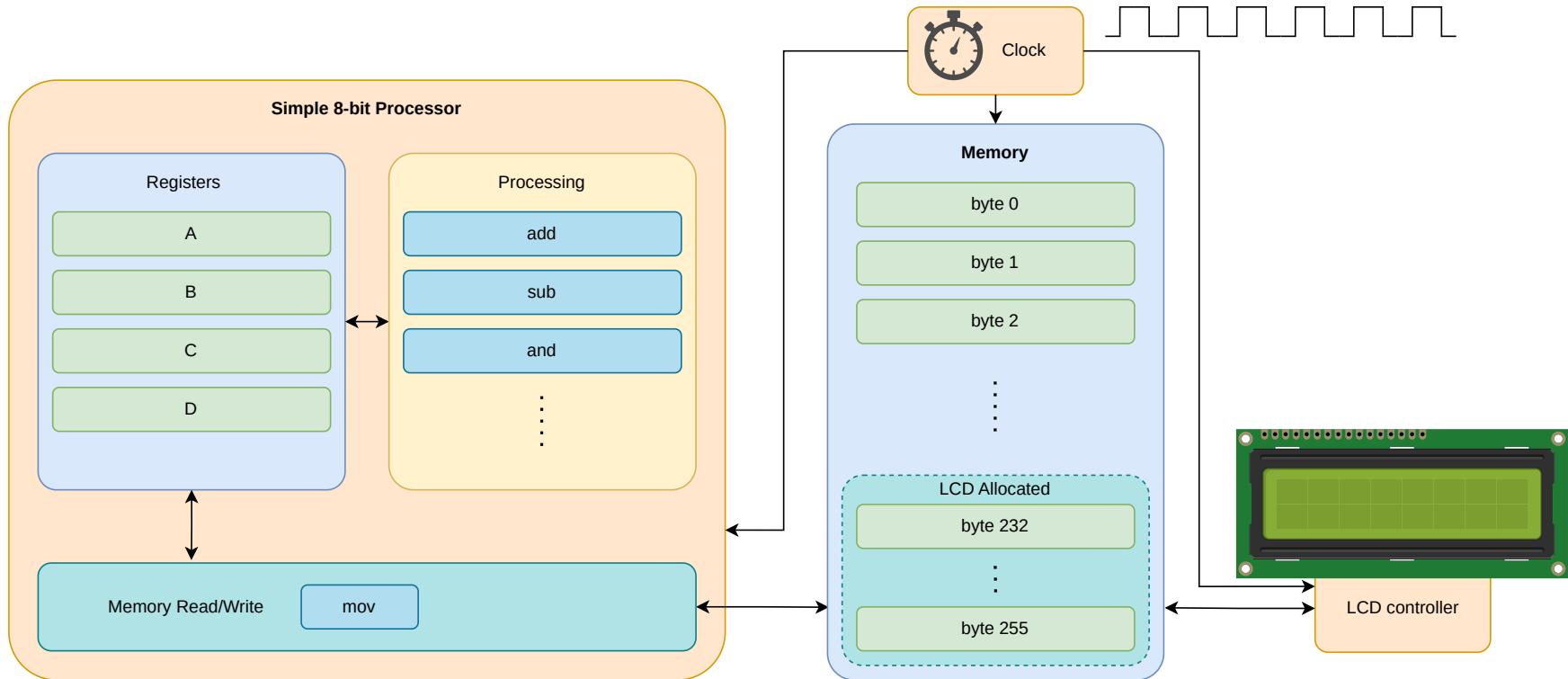



Programming

in Rust

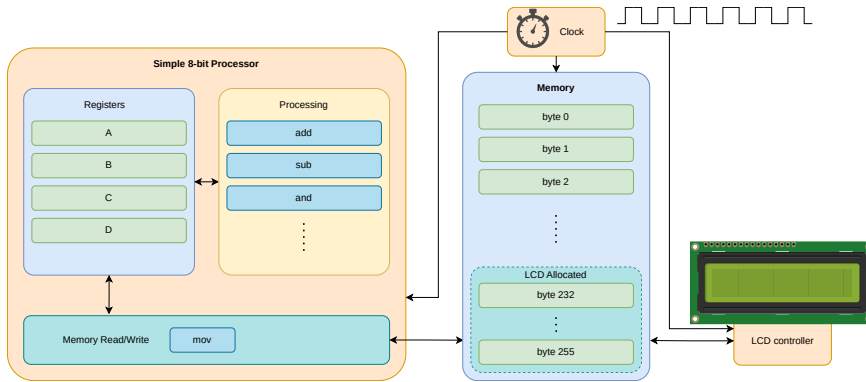

```
1 use eight_bit_processor::print;
2
3 static hello: &str = "Hello World!";
4
5 #[start]
6 fn start() {
7     print(hello);
8 }
```

Assembly

```
1     JMP start
2     hello: DB "Hello World!" ; Variable
3           DB 0 ; String terminator
4     start:
5         MOV C, hello ; Point to var
6         MOV D, 232 ; Point to output
7         CALL print
8         HLT ; Stop execution
9     print: ; print(C:*from, D:*to)
10        PUSH A
11        PUSH B
12        MOV B, 0
13    .loop:
14        MOV A, [C] ; Get char from var
15        MOV [D], A ; Write to output
16        INC C
17        INC D
18        CMP B, [C] ; Check if end
19        JNZ .loop ; jump if not
20
21        POP B
22        POP A
23        RET
```

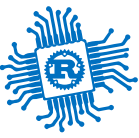

Demo

a working example for the previous code

Start

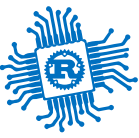

Microprocessors VS Microcontrollers

Microcontroller

A microcontroller is a small computer on a single integrated circuit (IC).

Microprocessor

A microprocessor is a computer central processing unit (CPU) on a single integrated circuit (IC).

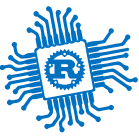

Comparison

Characteristic	Microcontroller	Microprocessor
Function	Includes CPU, mem & I/O	Includes only the CPU
Cost	>> <i>cheaper</i>	>> <i>expensive</i>
Complexity	>> <i>simple</i>	>> <i>complex</i>
Use case	<i>Incorporated devices</i>	<i>PCs, Servers, Laptops</i>

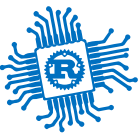

Graphic representation

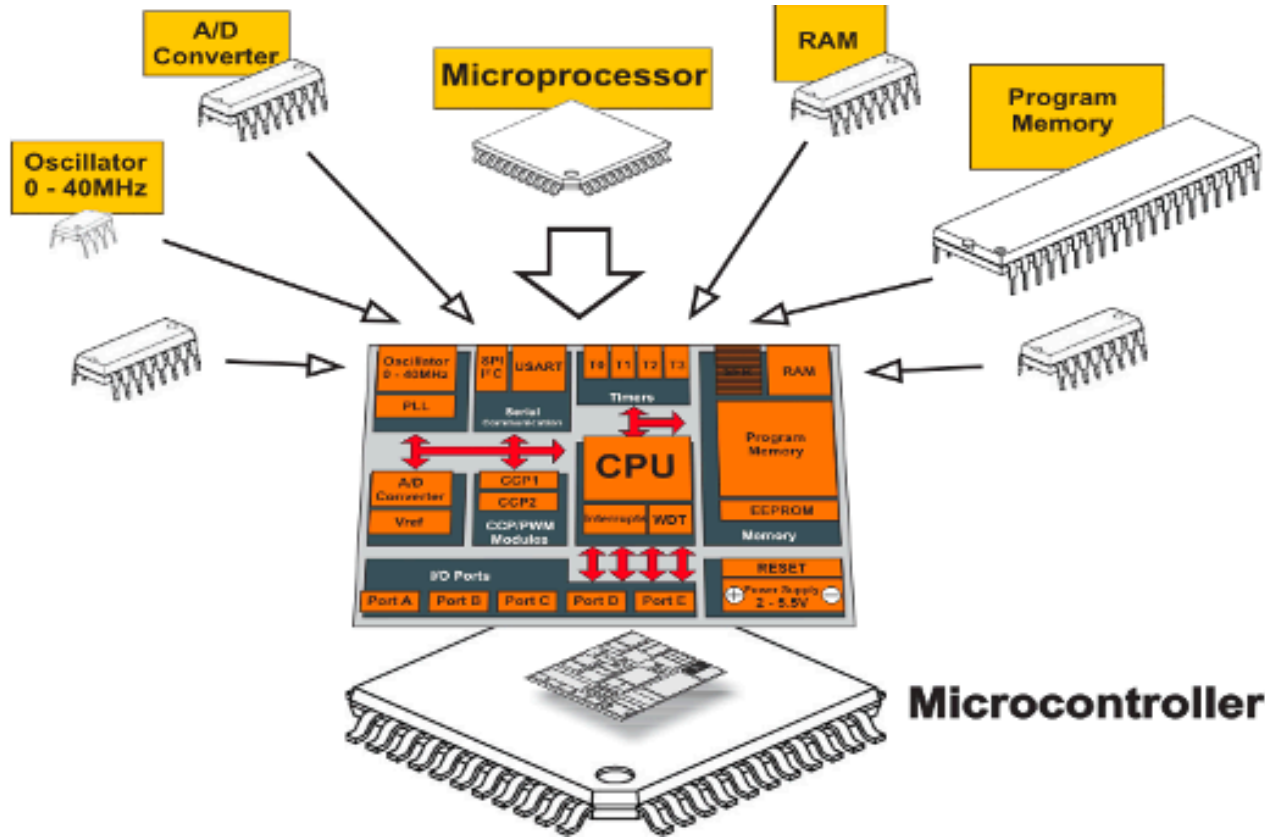



Note: why a motherboard



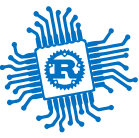

Note: von Neumann VS Harvard

From the point of view of memory access, there are 2 architectures:

von Neumann, where memory contains both instructions and data.

Today's PCs are all von Neumann

Harvard, where memory access is done on separate buses, one for data, one for instructions.

AVR, PIC, DSPs and many microcontrollers are Harvard

Note: ARM is von Neumann with some * Note: GPUs (NVIDIA) are mixed architecture

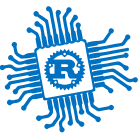

Note: microcontrollers - general observations

Microcontroller (MCU) – a mini computer on a single silicon chip that integrates:

Processor

Data memory

Program memory

Peripherals

In contrast to a microprocessor that needs other external chips for memory, control, peripherals



Under the microscope

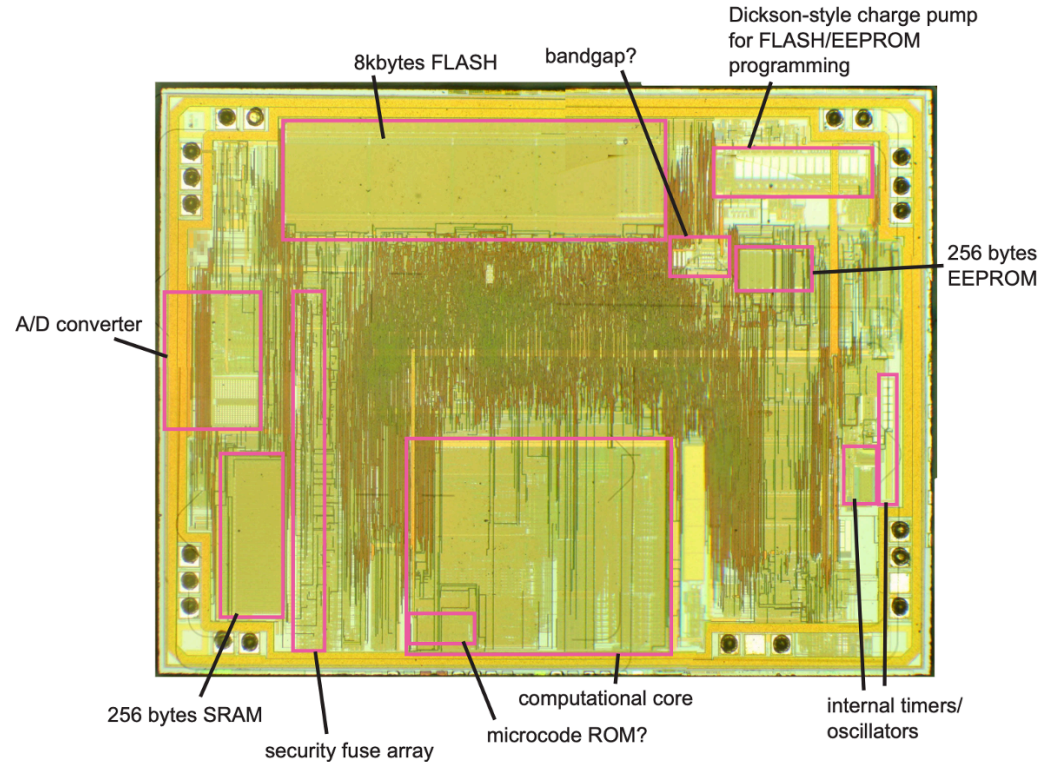

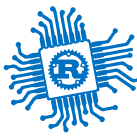

(extra)

©
<https://www.tomshardware.com/news/amd-shares-new-second-gen-3d-v-cache-chiplet-details-up-to-25-tbs>

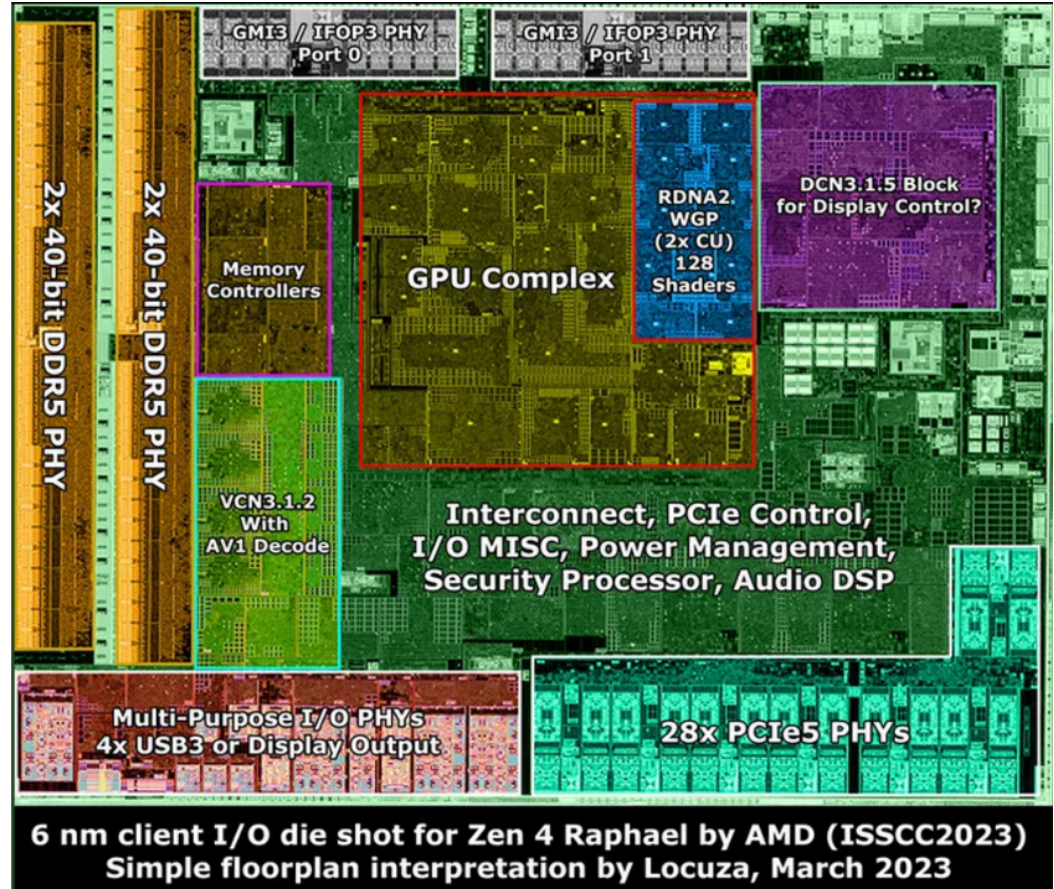

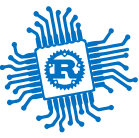

Types

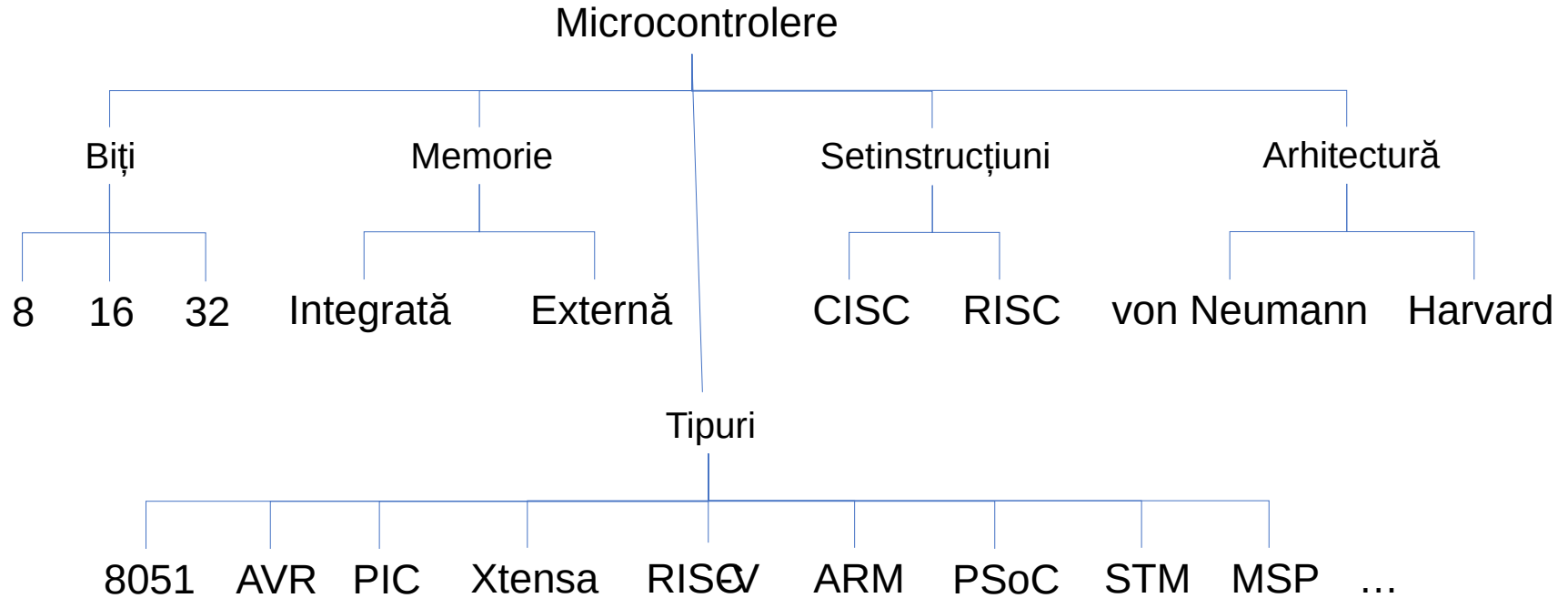

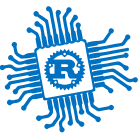

How to choose the right one ?

- ? Energy consumption
 - ? Operating frequency
 - ? IO Pins & Supported Peripheral / Interface Types
- (discussion)
- ? Memory
 - ? Internal functions
 - ? Software availability & support!

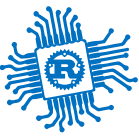

Hello World on AVR in C

```
1  #include <avr/io.h>
2  #include <util/delay.h>
3
4  #define F_CPU 12000000UL //MCU clock frequency
5
6  int main()
7  {
8      DDRC = (1 << PC0); //Set pin 0 of PORT C as output
9      //DDRC = Data Direction Register for PORT C
10     while(1)
11     {
12         PORTC ^= (1 << PC0); //Toggle pin 0 of PORT C (XOR)
13         _delay_ms(500);
14     }
15 }
```

Note: the above code can toggle an LED on/ off every 500ms



Let's go lower level

```
1 //00000000 <__vectors>:
2 //__vectors():
3 0: 0c 94 3e 00 jmp 0x7c ; 0x7c <__ctors_end> //reset
4 4: 0c 94 48 00 jmp 0x90 ; 0x90 <__bad_interrupt>
5 8: 0c 94 48 00 jmp 0x90 ; 0x90 <__bad_interrupt>
6 c: 0c 94 48 00 jmp 0x90 ; 0x90 <__bad_interrupt>
7 10: 0c 94 48 00 jmp 0x90 ; 0x90 <__bad_interrupt>
8 14: 0c 94 48 00 jmp 0x90 ; 0x90 <__bad_interrupt>
9 18: 0c 94 48 00 jmp 0x90 ; 0x90 <__bad_interrupt>
10 1c: 0c 94 48 00 jmp 0x90 ; 0x90 <__bad_interrupt>
11 20: 0c 94 48 00 jmp 0x90 ; 0x90 <__bad_interrupt>
12 24: 0c 94 48 00 jmp 0x90 ; 0x90 <__bad_interrupt>
13 28: 0c 94 48 00 jmp 0x90 ; 0x90 <__bad_interrupt>
14
15 .....
16
17 60: 0c 94 48 00 jmp 0x90 ; 0x90 <__bad_interrupt>
18 64: 0c 94 48 00 jmp 0x90 ; 0x90 <__bad_interrupt>
19 68: 0c 94 48 00 jmp 0x90 ; 0x90 <__bad_interrupt>
20 6c: 0c 94 48 00 jmp 0x90 ; 0x90 <__bad_interrupt>
21 70: 0c 94 48 00 jmp 0x90 ; 0x90 <__bad_interrupt>
22 74: 0c 94 48 00 jmp 0x90 ; 0x90 <__bad_interrupt>
23 78: 0c 94 48 00 jmp 0x90 ; 0x90 <__bad_interrupt>
24 0000007c <__ctors_end>:
```

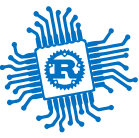

Next code

```
1  //__trampolines_start():
2      7c: 11 24 eor r1, r1    ; r1 = 0           //program jumps here at reset
3      7e: 1f be out 0x3f, r1  ; SREG = r1
4      80: cf ef ldi r28, 0xFF ; 255
5      82: d8 e0 ldi r29, 0x08 ; 8
6      84: de bf out 0x3e, r29 ; SPH = 0x8       //stack pointer on the last RAM address - 0x08FF for 328P
7      86: cd bf out 0x3d, r28 ; SPL = 0xFF.     //stack Pointer High and Low - to get a 16b address on a 8bit MCU
8      88: 0e 94 4a 00 call 0x94    ; 0x94 <main>
9      8c: 0c 94 59 00 jmp 0xb2    ; 0xb2 <_exit> 00000090
10
11 //<__bad_interrupt>: __vector_22():
12      90: 0c 94 00 00 jmp 0    ; 0x0 <__vectors>. //any interrupt triggers a reset
```

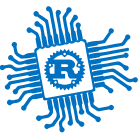

We get to the code

```
1      94: 38 9a sbi 0x07, 0 ; DDRC = 0x01          //DDRC |= (1 << PC0);
2
3      96: 91 e0 ldi r25, 0x01 ; r25 = 1
4      98: 88 b1 in r24, 0x08 ; r24 = PORTC          //from here PORTC ^= (1 << PC0);
5      9a: 89 27 eor r24, r25 ; r24 = r24 ^ 1
6      9c: 88 b9 out 0x08, r24 ; PORTC = r24
7
8      9e: 2f e9 ldi r18, 0x9F ; 159                //from here _delay_ms():
9      a0: 36 e8 ldi r19, 0x86 ; 134
10     a2: 81 e0 ldi r24, 0x01 ; 1
11     a4: 21 50 subi r18, 0x01 ; 1
12     a6: 30 40 sbci r19, 0x00 ; 0
13     a8: 80 40 sbci r24, 0x00 ; 0
14     aa: e1 f7 brne .-8 ; 0xa4 <main+0x10>
15     ac: 00 c0 rjmp .+0 ; 0xae <main+0x1a>
16     ae: 00 00 nop b0: f3 cf rjmp .-26 ; 0x98 <main+0x4> //jumps back to the loop (98)
```

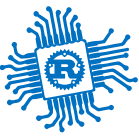

Real World Microcontrollers

Intel / AVR / PIC / TriCore / ARM Cortex-M / RISC-V rv32i(a)mc



Bibliography

for this section

Joseph Yiu, *The Definitive Guide to ARM® Cortex®-M0 and Cortex-M0+ Processors, 2nd Edition*

- Chapter 1 - *Introduction*
- Chapter 2 - *Technical Overview*

Intel

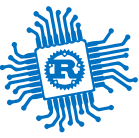

Vendor	Intel
ISA	8051, 8051
Word	8 bit
Frequency	a few MHz
Storage	?
Variants	<i>8048, 8051</i>



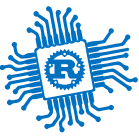

AVR

probably *Alf and Vegard's RISC processor*

Authors	Alf-Egil Bogen and Vegard Wollan
Vendor	Microchip (<i>Atmel</i>)
ISA	AVR
Word	8 bit
Frequency	1 - 20 MHz
Storage	4 - 256 KB
Variants	<i>ATmega, ATtiny</i>

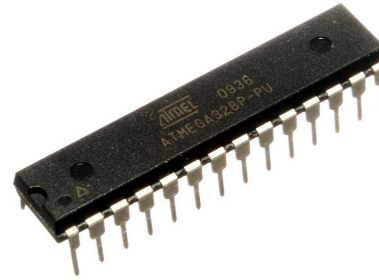

Board

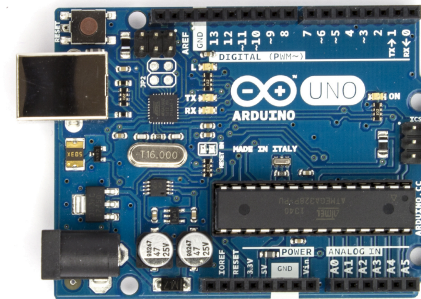



PIC

Peripheral Interface Controller / Programmable Intelligent Computer

Vendor	Microchip
ISA	PIC
Word	8 - 32
Frequency	1 - 20 MHz
Storage	256 B - 64 KB
Variants	<i>PIC10, PIC12, PIC16, PIC18, PIC24, PIC32</i>

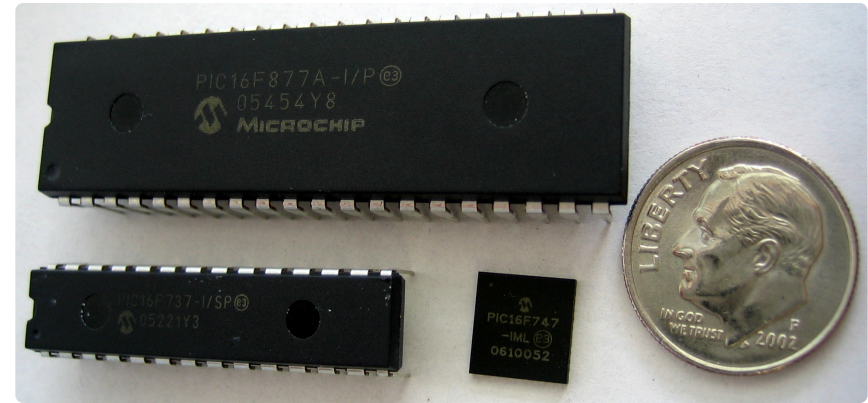



TriCore

Vendor	Infineon
ISA	AURIX32
Word	32 bit
Frequency	hundreds of MHz
Storage	a few MB
Variants	<i>TC2xx, TC3xx, TC4xx</i>



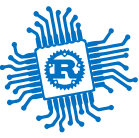

ARM Cortex-M

Advanced RISC Machine

Vendor	Qualcomm, NXP, Nordic Semiconductor, Broadcom, Raspberry Pi
ISA	ARMv6-M (Thumb and some Thumb-2) ARMv7-M (Thumb and Thumb-2) ARMv8-M (Thumb and Thumb-2)
Word	32
Frequency	1 - 900 MHz
Storage	up to a few MB
Variants	<i>M0, M0+, M3, M4, M7, M23, M33</i>



ARM Cortex-M Instruction Set

what the MCU can do

Fun Facts

- M0/M0+ has no `div`
- M0 - M3 have no floating point
- M23 and M33 have security extensions

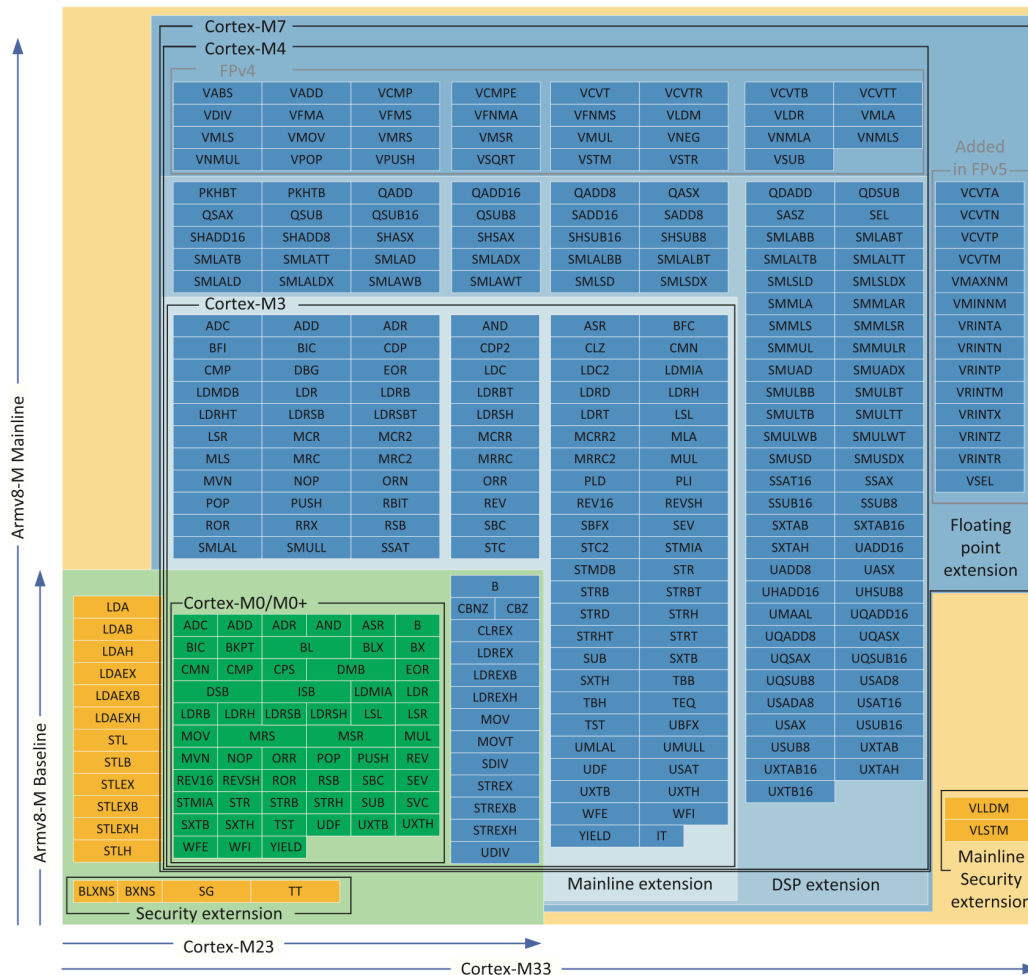



RISC-V rv32i(a)mc

Fifth generation of RISC ISA

Authors	University of California, Berkeley
Vendor	Espressif System
ISA	rv32i(a)mc
Word	32 bit
Frequency	1 - 200 MHz
Storage	4 - 256 KB
Variants	<i>rv32imc, rv32iamc</i>





RP2350

ARM Cortex-M33, built by Raspberry Pi

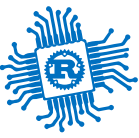

Bibliography

for this section

Raspberry Pi Ltd, *RP2350 Datasheet*

- Chapter 1 - *Introduction*
- Chapter 2 - *System Description*
 - Section 2.1 - *Bus Fabric*

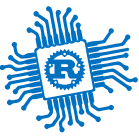

RP2350

the MCU

Boards

that use RP2350

Raspberry Pi Pico 2 (W)

Vendor	Raspberry Pi
Variant	ARM Cortex-M33 / Hazard3 RISC-V
ISA	ARMv8-M / rv32iamc
Cores	2
Word	32 bit
Frequency	up to 150 MHz
RAM	520 KB

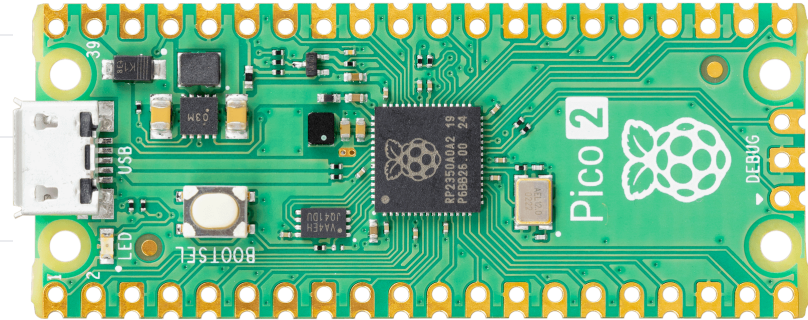

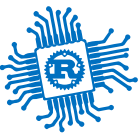

The Chip

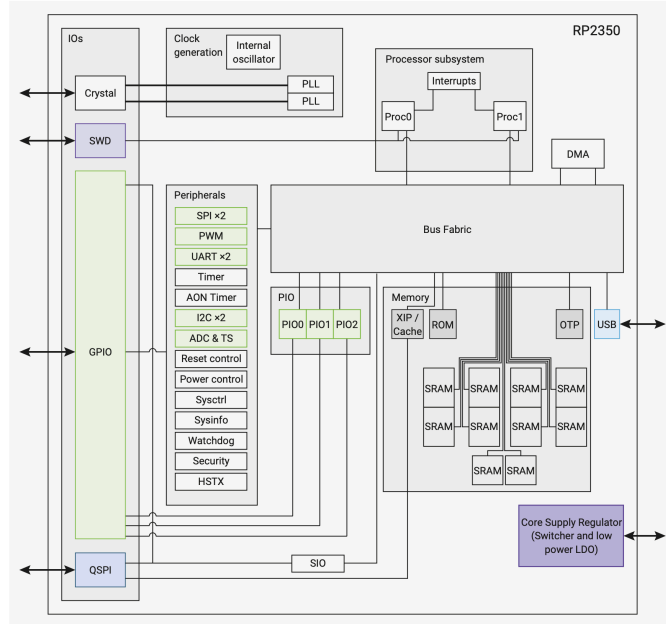

GPIO: General Purpose Input/Output

SWD: Debug Protocol

DMA: Direct Memory Access

[Datasheet RP2350](#)

Peripherals

SIO Single Cycle I/O (implements GPIO)

PWM Pulse Width Modulation

ADC Analog to Digital Converter

(Q)SPI (Quad) Serial Peripheral Interface

UART Universal Async. Receiver/Transmitter

RTC Real Time Clock

I2C Inter-Integrated Circuit

PIO Programmable Input/Output



Pins

have multiple functions

GPIO	F0	F1	F2	F3	F4	F5	F6	F7	F8	F9	F10	F11
0		SPI0 RX	UART0 TX	I2C0 SDA	PWM0 A	SIO	PI00	PI01	PI02	QMI CS1n	USB OVCUR DET	
1		SPI0 CSn	UART0 RX	I2C0 SCL	PWM0 B	SIO	PI00	PI01	PI02	TRACELCK	USB VBUS DET	
2		SPI0 SCK	UART0 CTS	I2C1 SDA	PWM1 A	SIO	PI00	PI01	PI02	TRACEDATA0	USB VBUS EN	UART0 TX
3		SPI0 TX	UART0 RTS	I2C1 SCL	PWM1 B	SIO	PI00	PI01	PI02	TRACEDATA1	USB OVCUR DET	UART0 RX
4		SPI0 RX	UART1 TX	I2C0 SDA	PWM2 A	SIO	PI00	PI01	PI02	TRACEDATA2	USB VBUS DET	
5		SPI0 CSn	UART1 RX	I2C0 SCL	PWM2 B	SIO	PI00	PI01	PI02	TRACEDATA3	USB VBUS EN	
6		SPI0 SCK	UART1 CTS	I2C1 SDA	PWM3 A	SIO	PI00	PI01	PI02		USB OVCUR DET	UART1 TX
7		SPI0 TX	UART1 RTS	I2C1 SCL	PWM3 B	SIO	PI00	PI01	PI02		USB VBUS DET	UART1 RX
8		SPI1 RX	UART1 TX	I2C0 SDA	PWM4 A	SIO	PI00	PI01	PI02	QMI CS1n	USB VBUS EN	
9		SPI1 CSn	UART1 RX	I2C0 SCL	PWM4 B	SIO	PI00	PI01	PI02		USB OVCUR DET	
10		SPI1 SCK	UART1 CTS	I2C1 SDA	PWM5 A	SIO	PI00	PI01	PI02		USB VBUS DET	UART1 TX
11		SPI1 TX	UART1 RTS	I2C1 SCL	PWM5 B	SIO	PI00	PI01	PI02		USB VBUS EN	UART1 RX
12	HSTX	SPI1 RX	UART0 TX	I2C0 SDA	PWM6 A	SIO	PI00	PI01	PI02	CLOCK GPIN0	USB OVCUR DET	
13	HSTX	SPI1 CSn	UART0 RX	I2C0 SCL	PWM6 B	SIO	PI00	PI01	PI02	CLOCK GPIN0	USB VBUS DET	
14	HSTX	SPI1 SCK	UART0 CTS	I2C1 SDA	PWM7 A	SIO	PI00	PI01	PI02	CLOCK GPIN1	USB VBUS EN	UART0 TX
15	HSTX	SPI1 TX	UART0 RTS	I2C1 SCL	PWM7 B	SIO	PI00	PI01	PI02	CLOCK GPIN1	USB OVCUR DET	UART0 RX
16	HSTX	SPI0 RX	UART0 TX	I2C0 SDA	PWM0 A	SIO	PI00	PI01	PI02		USB VBUS DET	
17	HSTX	SPI0 CSn	UART0 RX	I2C0 SCL	PWM0 B	SIO	PI00	PI01	PI02		USB VBUS EN	
18	HSTX	SPI0 SCK	UART0 CTS	I2C1 SDA	PWM1 A	SIO	PI00	PI01	PI02		USB OVCUR DET	UART0 TX
19	HSTX	SPI0 TX	UART0 RTS	I2C1 SCL	PWM1 B	SIO	PI00	PI01	PI02	QMI CS1n	USB VBUS DET	UART0 RX
20		SPI0 RX	UART1 TX	I2C0 SDA	PWM2 A	SIO	PI00	PI01	PI02	CLOCK GPIN0	USB VBUS EN	
21		SPI0 CSn	UART1 RX	I2C0 SCL	PWM2 B	SIO	PI00	PI01	PI02	CLOCK GPIN0	USB OVCUR DET	
22		SPI0 SCK	UART1 CTS	I2C1 SDA	PWM3 A	SIO	PI00	PI01	PI02	CLOCK GPIN1	USB VBUS DET	UART1 TX

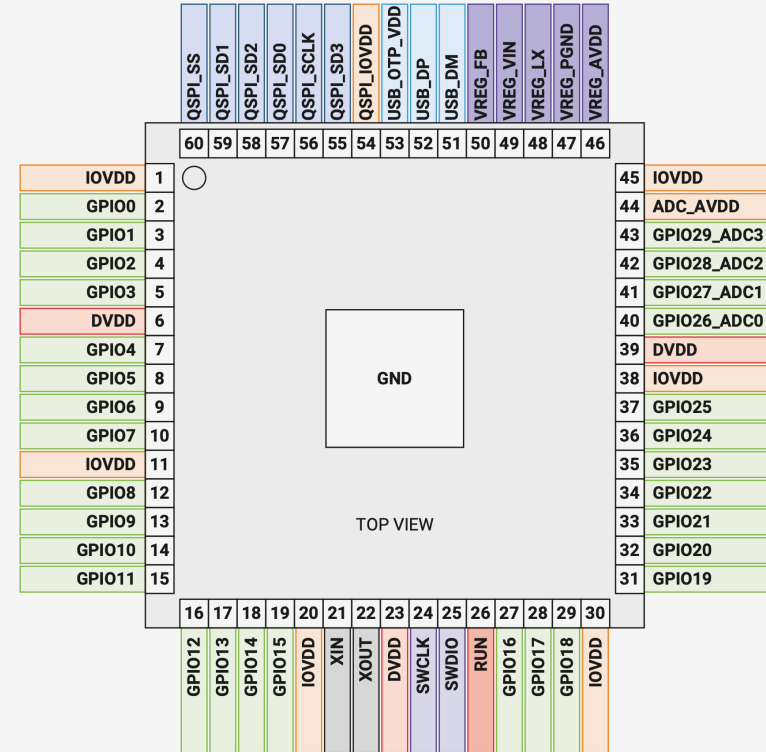

...

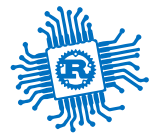

The Bus

that interconnects the cores with the peripherals

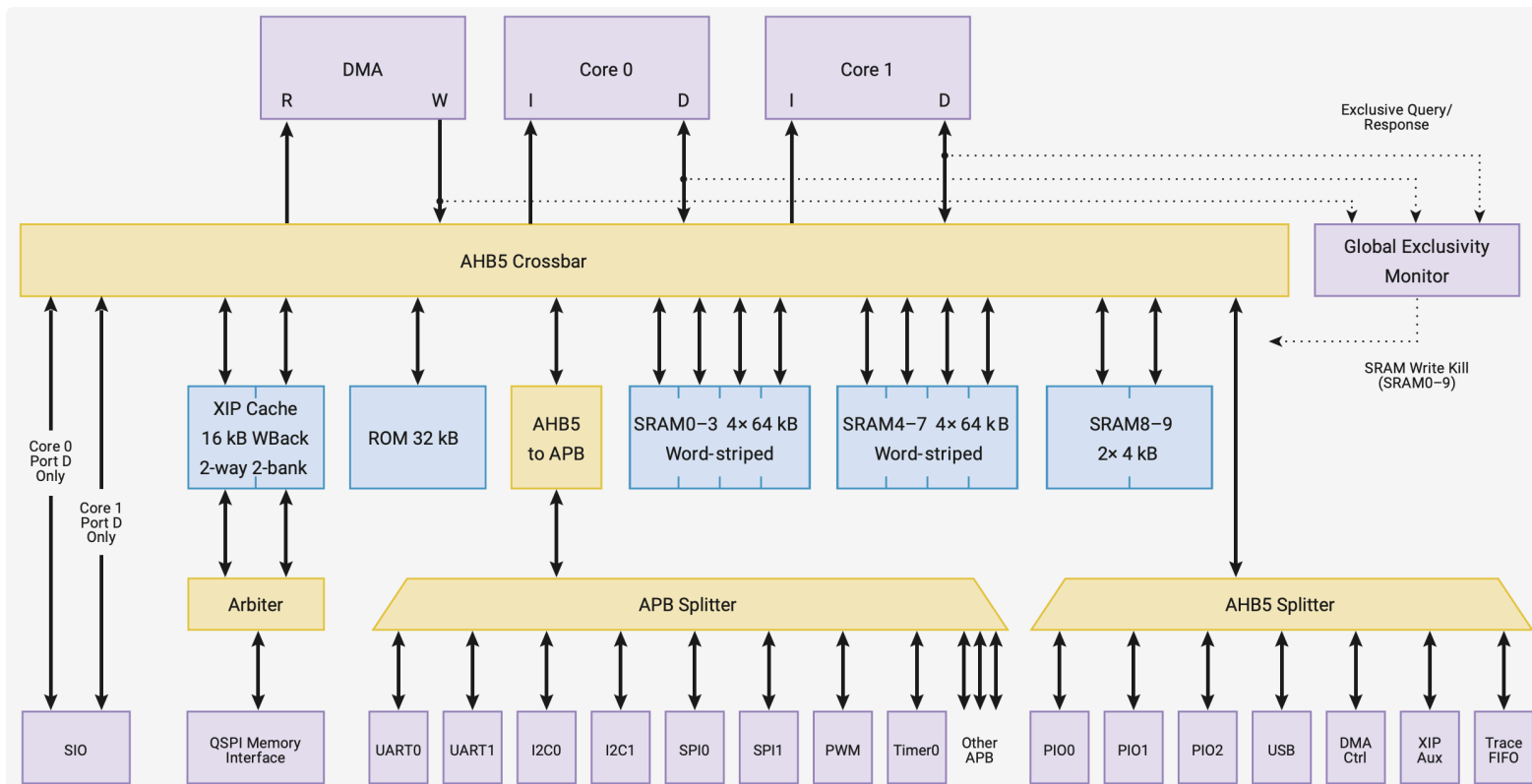

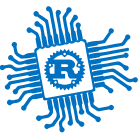

Conclusion

we talked about

- How a processor functions
- Microcontrollers (MCU) / Microprocessors (CPU)
- Microcontroller architectures
- ARM Cortex-M
- RP2040

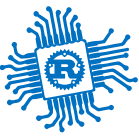

Atmega328P

the MCU

Boards

that use 328P - many :)

Example: Arduino Uno

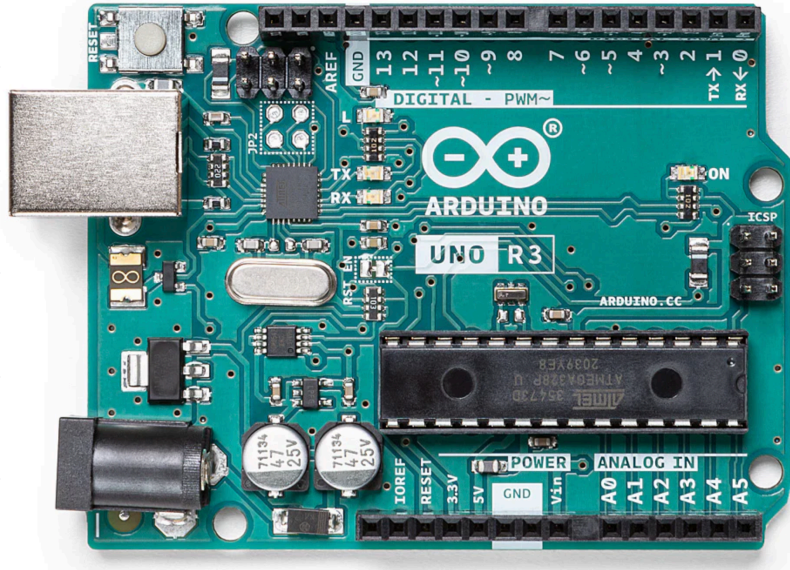

Vendor	Arduino & others
Variant	328p/ 328P
Cores	1
Word	8 bit
Frequency	up to 16 MHz
RAM	2 KB
Storage	32KB Flash & 1 KB EEPROM

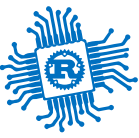

The Chip

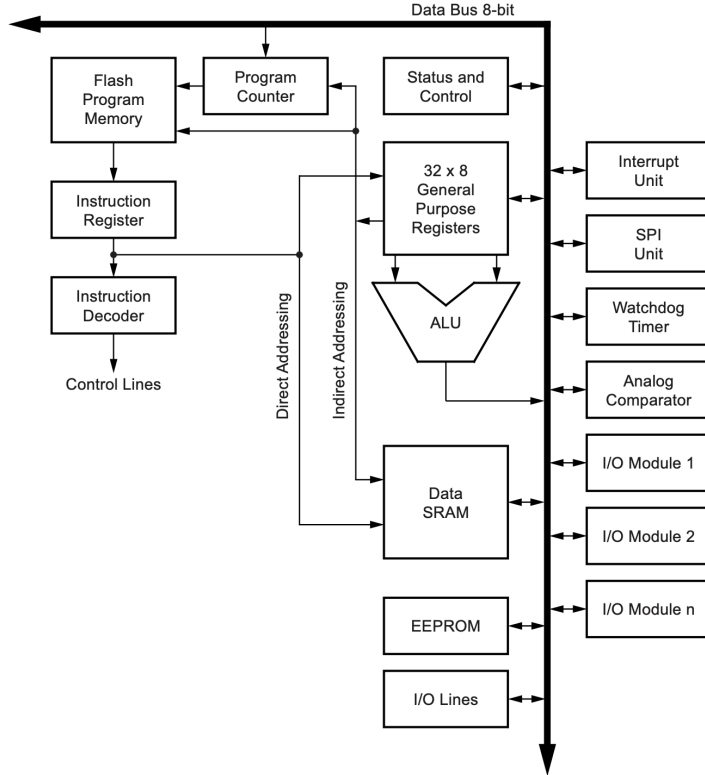

Peripherals

PWM	Pulse Width Modulation
ADC	Analog to Digital Converter
SPI	Serial Peripheral Interface
UART	Universal Async. Receiver/Transmitter
RTC	Real Time Clock
I2C	Inter-Integrated Circuit [1]
PIO	Programmable Input/Output

1. Actually 2-wire serial interface ↔

Pins

have multiple functions

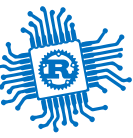

The Bus

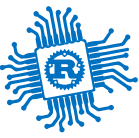

For more details - check-out the [328P DataSheet](#)

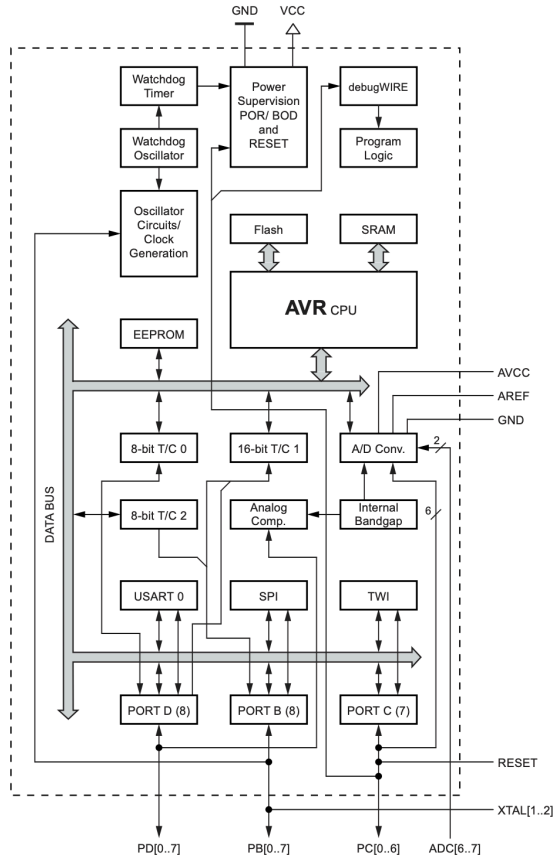

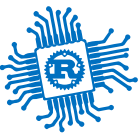

Embedded Software



Why Embedded Software is Different

It tends to be very application-specific

- It comes in the form of a blob, which contains data, configuration, application and drivers
- While some operating systems exist for embedded devices, they are very rare

It uses specialized hardware to achieve its goal

- DSPs for audio/video processing
- On-chip/off-chip peripherals (ADCs/DACs for data acquisition, audio playback, capacitive touch)
- Displays, buttons for user interfaces

It is much more tightly coupled to hardware than PC/server software

- This allows for smaller binaries but the trade-off is less portable code
- It must be designed in parallel with the hardware



Hardware Programming & Debugging Devices

Software tools + hardware tools:

- IDE
- compiler
- programming device/ debugger
- hardware device

Extras:

- oscilloscope
- waveform analyzer
- power analyzer

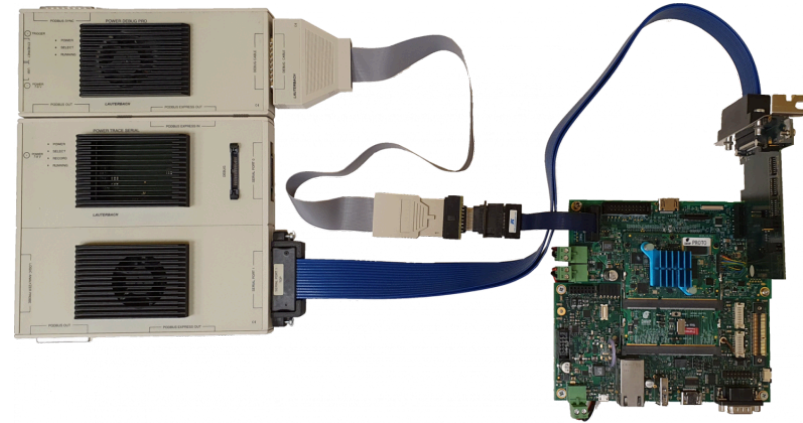

[1]

1. https://wiki.dave.eu/index.php/MITO8M-AN-001:Advanced_multicore_debugging,_tracing,_and_energy_profiling_with_Lauterbach_TRACE32 ↔



Program Flow - ARM vs AVR

What	ARM	AVR
Program Load	Using an external programmer or bootloader	(same)
Execution launch	When the microcontroller is reset, execution starts from a preset address	(same)
Execution threads	Supports multiple threads, multiple values for the Program Counter PC (R15)	Single thread, controlled by PC (Program Counter)
In/ Out interaction	Memory mapped I/O	Port-mapped I/O

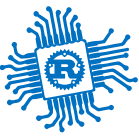

The code

How do we program a microcontroller?

1. The code is compiled and a binary file containing the machine code instructions is produced.

- .UF2 / .BIN / .HEX on ARM
- .HEX on AVR

2. The binary must end up in the microcontroller's program memory (Flash) ^[1]

- Using an external programmer (In-System Programmer or JTAG)
- using a bootloader

The bootloader takes up space in the program memory for AVR (for RPI it resides in ROM).

3. After programming, a RESET is automatically applied to the processor, and it starts execution from the start address.

Depending on the configuration (eg where the bootloader is written), it may not be 0.

1. ARM microcontrollers are able to execute code from RAM ↔

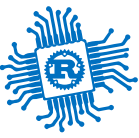

In / Out

No

- screen :)
- console :)

Yes

- LEDs
- LCD
- Serial interface
- Hardware Debugger



Variables

Allocation

- Local variables > stack

Be careful when using recursive functions

- Global variables > data

- Dynamic variables > heap

Dynamic variables require an allocator - might not be ideal on an AVR / when you are low on memory

- Const > flash memory (program memory - written at compile time)

Const on AVR can also be stored on EEPROM (slow)

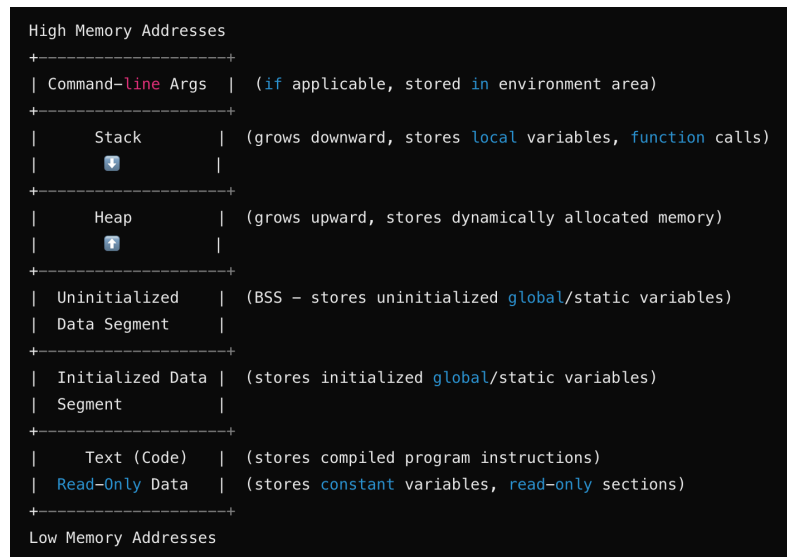

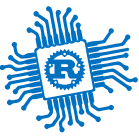

Memory on AVR - 328P example

ATmega328P Memory Details

Memory Type	Size	Purpose
Flash (ROM)	32 KB	Stores program instructions (non-volatile).
SRAM (RAM)	2 KB	Stores variables, stack, heap, and registers.
EEPROM	1 KB	Stores persistent data (non-volatile, writable).
General Purpose Registers	32 Bytes	Fast-access CPU registers.
I/O Registers	64 Bytes	Port-mapped peripheral control registers.
Extended I/O Registers	160 Bytes	Memory mapped peripheral control registers.



Memory on ARM - RP2350 example - M33 based

RP2350 Memory Breakdown

Memory Type	Size	Purpose
XIP ^[1] Flash	Up to 16 MB	Stores program code (external QSPI Flash).
SRAM (On-chip)	520 KB	Stores stack, heap, variables, and data.
Boot ROM	32 KB	Stores bootloader, factory firmware.
OTP	8 KB	One-time-programmable (Product id, cryptographic keys).
Peripheral Space	Varies	Memory-mapped I/O for GPIO, UART, SPI, DMA.
Registers	16 + control registers	General purpose + program flow + special purpose

-
1. XIP = Execute in Place (without this, the code would need to be copied in RAM first) ↔



Let's see some code

```
1  #include <stdio.h>
2  #include <stdint.h>
3
4  void printBinary(uint32_t num) {
5      for (int i = 31; i >= 0; i--) {
6          printf("%d", (num >> i) & 1);
7          if (i % 8 == 0) printf(" ");
8      }
9      printf("\n");
10 }
11
12 int main()
13 {
14     uint8_t a;
15     uint32_t b;
16
17     a = 0x01;
18     b = a << 24;
19
20     printBinary(a);
21     printBinary(b);
22
23     return 0;
24 }
```

What is the resulting value?

it depends on the compiler and on the architecture

Solution

```
1  b = (uint32_t) a << 24;
2  //b will be 00000001 00000000 00000000 00000000
3  //same result on any architecture and compiler;
```

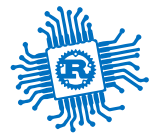

Variables in C

```
1  #include <stdio.h>
2
3  int8_t, uint8_t
4  int16_t, uint16_t
5  int32_t, uint32_t
```

Variables in Rust

```
1  u8, u16, u32, u64, u128
2  i8, i16, i32, i64, i128
3  usize //word size (eg - 32b for 32b processor)
4  isize //word size (eg - 32b for 32b processor)
5
6  //NOTES:
7  char // 4 bytes != u8 //UTF-8 not ASCII like in C
8  b"str" //ASCII string
9  "str" UTF-8 string
10
11 's' // char
12 b's' // u8
```



Why Rust-lang

The tagline of Rust is No Undefined Behavior.

- no null reference; the Rust compiler explicitly asks developers to check this;
- no implicit cast, even adding a u32 to a u8 must be casted;
- safe access to shared data across threads verified at compile time;
- uses type states to move runtime checks to compile time and force developers to check;
- clearly defined data types, unlike i8 or u128;
- safe unions, that provide a discriminant to prevent wrong interpretation of data;
- clear code organization into crates and modules;
- backward compatibility at crate level.