



Exceptions and Interrupts

Lecture 9



Exceptions and Interrupts

used by RP2

- Exceptions
- Interrupts
- Boot



Exceptions

for the ARM Cortex-M processor

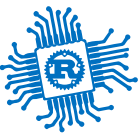

Bibliography

for this section

Joseph Yiu, *The Definitive Guide to ARM® Cortex®-M23 and Cortex-M33 Processors*

- Chapter 4 - *Architecture*
 - Section 4.5 - *Exceptions and Interrupts*
 - Subsection 4.4.1 - *What are exceptions*
- Chapter 8 - *Exceptions and Interrupts*
 - Section 8.1 - *What are Exceptions and Interrupts*
 - Section 8.2 - *Exception types+*

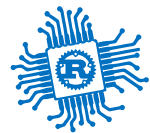

Processor Exceptions

what happens if something does not work as required

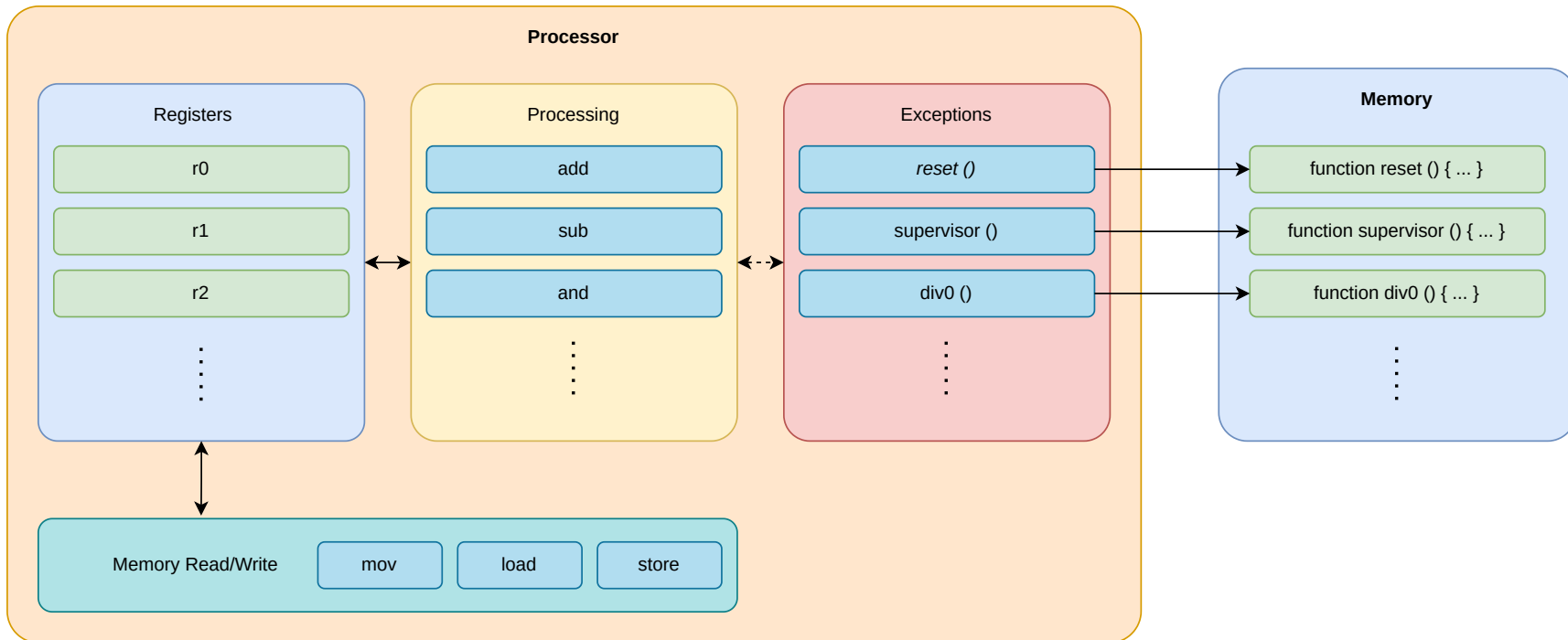



ARM Cortex-M Exceptions

what happens if something does not work as required

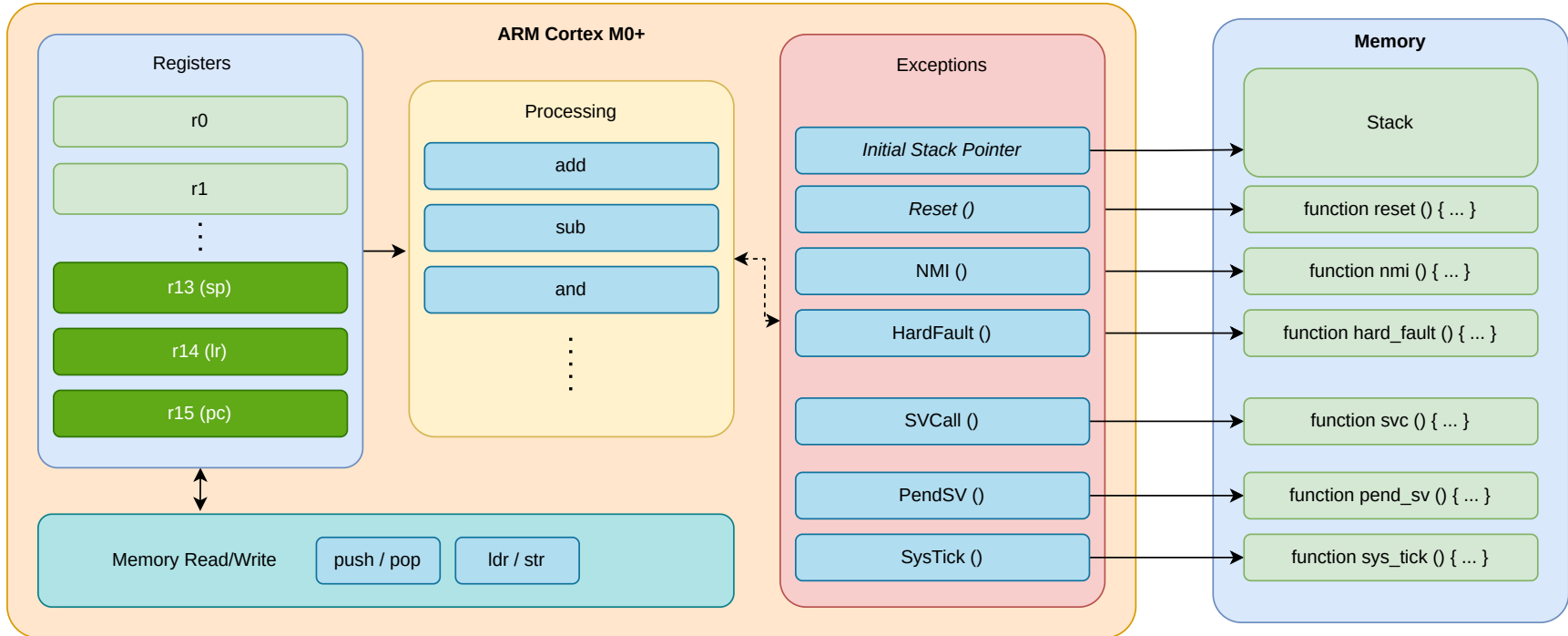

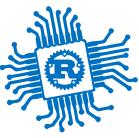

Exception (HardFault) Handling

ARM Cortex-M has one **actual** exception, *HardFault*

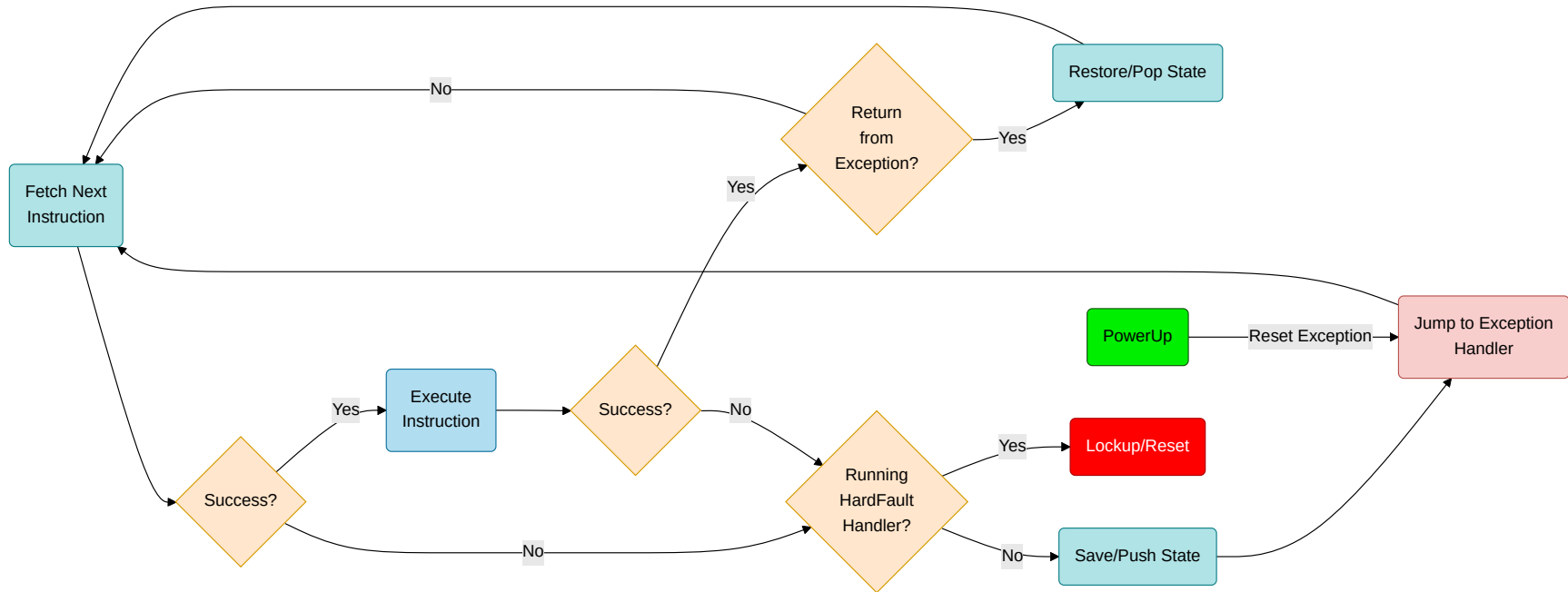

- the exception table of RP2040 at address 0x1000_0100, RP2350 at address 0x1000_0000
- the processor generates a *Reset* exception when it starts

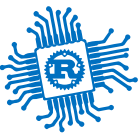

Interrupts

for ARM Cortex-M0+



Bibliography

for this section

Joseph Yiu, *The Definitive Guide to ARM® Cortex®-M0 and Cortex-M0+ Processors, 2nd Edition*

- Chapter 8 - *Exceptions and Interrupts*
 - Section 8.1 - *What are Exceptions and Interrupts*
 - Section 8.3 - *Brief Overview of the NVIC*
 - Section 8.4 - *Definition of Exception Priority Levels*
 - Section 8.5 - *Vector Table*
 - Section 8.6 - *Exception Sequence Overview*
- Chapter 11 - *Fault Handling*
 - Section 11.1 - *Fault Exception Overview*
 - Section 11.2 - *What Can Cause a Fault*
 - Section 11.7 - *Lockup*



ARM Cortex-M Interrupts

some hardware device notifies the MCU

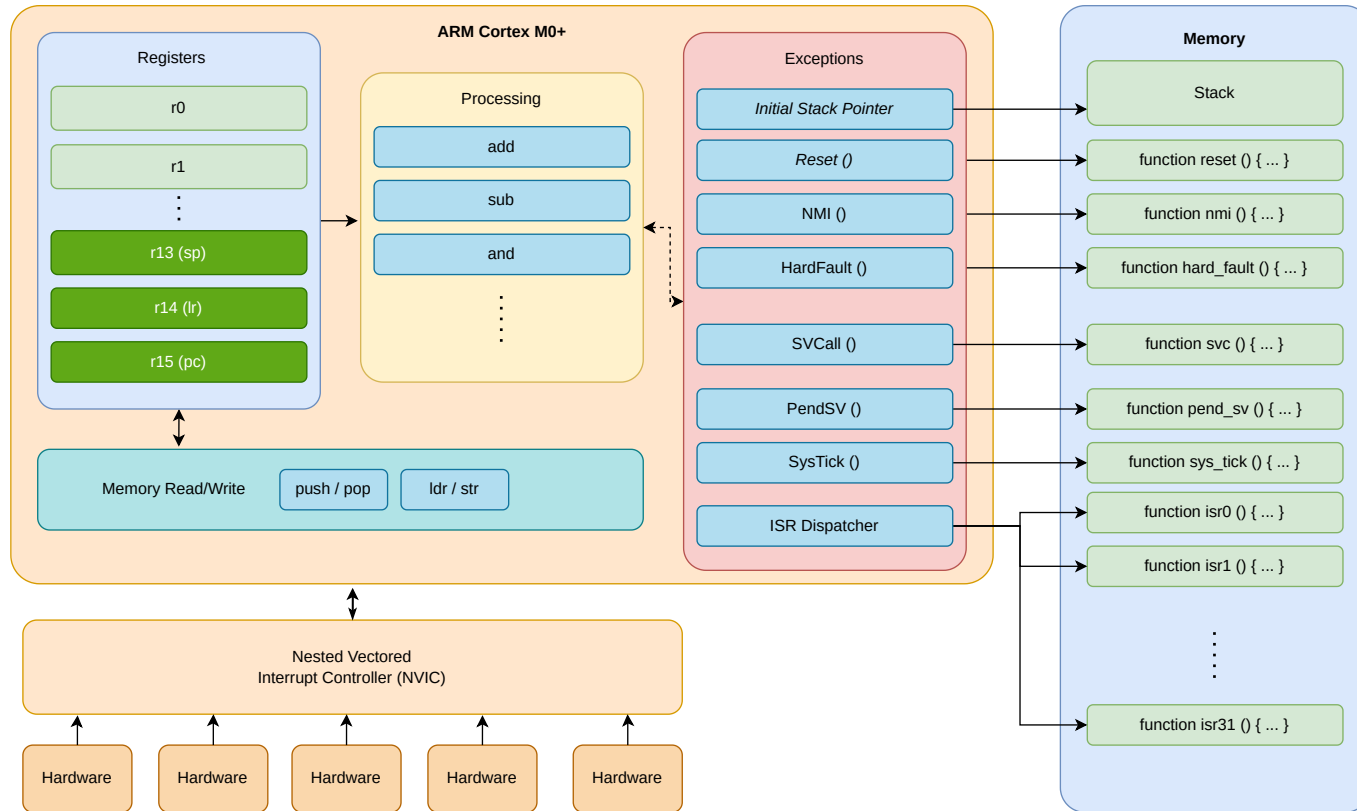



Interrupt Handling

ARM Cortex-M

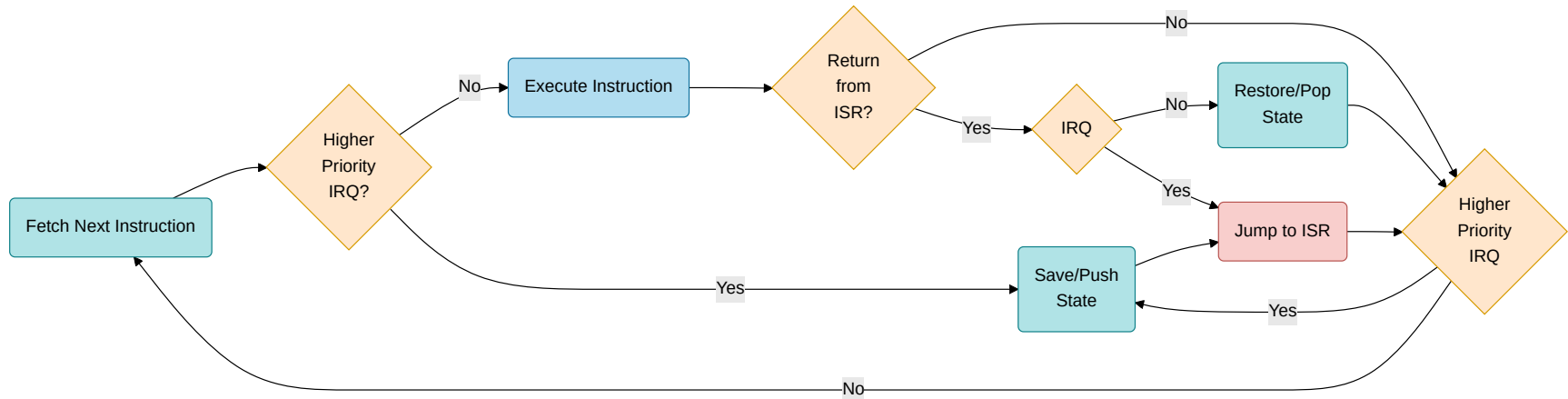

IRQ Interrupt Request

ISR Interrupt Service Routine

- the interrupt vector (table) of RP2350 starts at address 0x1000_0040 (after the exceptions table with 15 interrupts)
- ARM Cortex-M0+ has a maximum of 32 IRQs
- ARM Cortex-M33 has a maximum of 480 IRQs

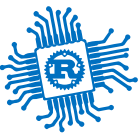

Exceptions are Software Interrupt Requests

with a negative IRQ number and a higher priority

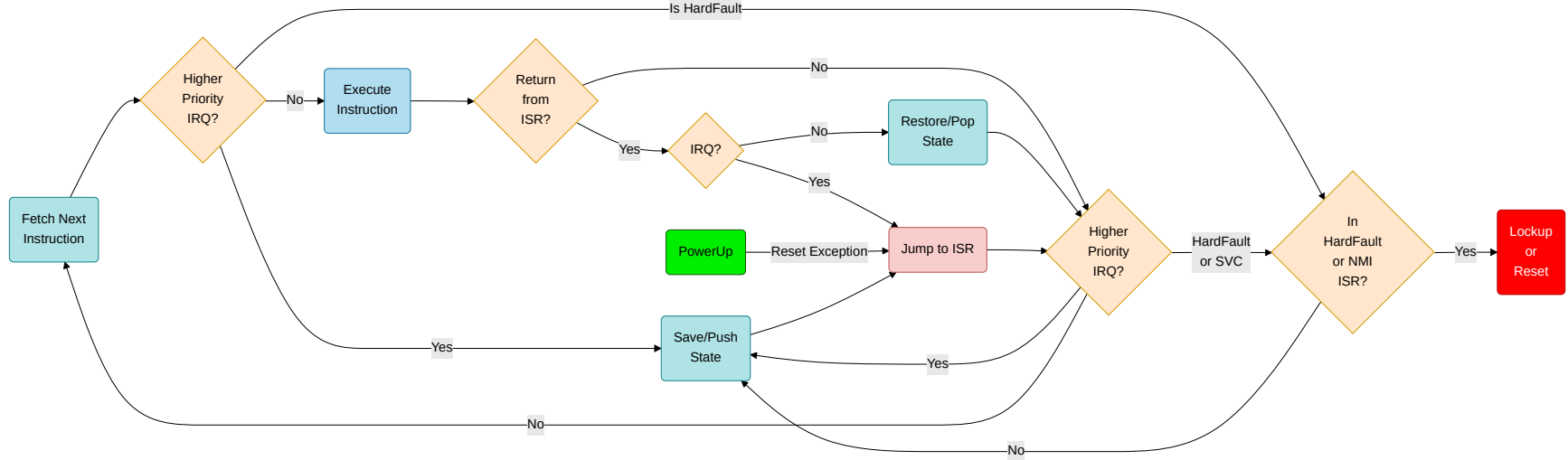



Boot

of the RP2040 and RP2350



Bibliography

for this section

Raspberry Pi Ltd, RP2040 Datasheet

- Chapter 2 - *System Description*
 - Section 2.7 - *Boot sequence*
 - Section 2.8 - *Bootrom*
 - Subsection 2.8.1 - *Processor Controlled Boot Sequence*

Raspberry Pi Ltd, RP2350 Datasheet

- Chapter 5 - *Bootrom*
 - Section 5.1 - *Bootrom concepts*

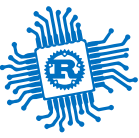

Boot

how the ARM Cortex-M starts

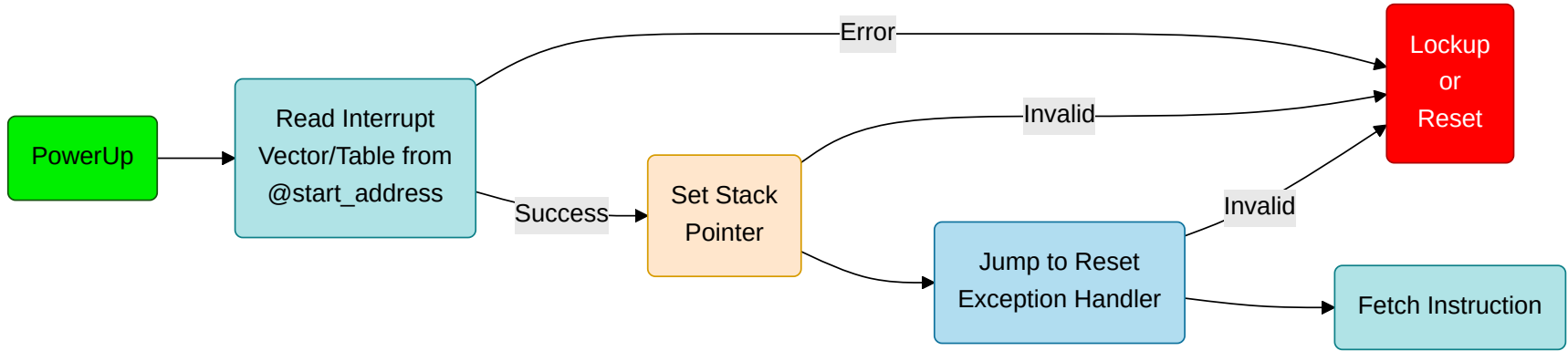

- the *start_address* for RP2040 is 0x1000_0100
- the *start_address* for RP2350 depends on the *Start Block* items
- RP2040 & RP2350 have another boot loader that it loads from 0x0000_0000

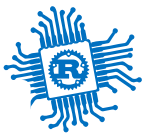

Boot

The RP2040 boot process

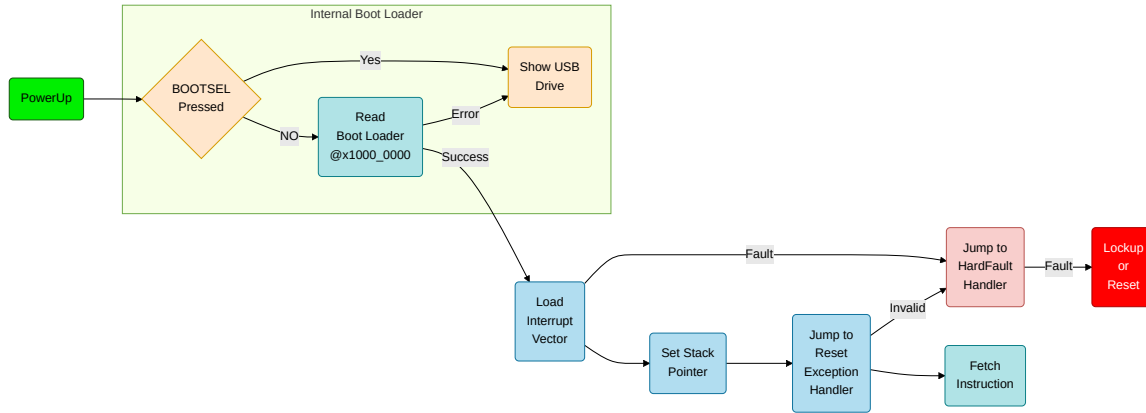

The internal boot loader cannot be overwritten and assures that bricking the device is difficult.

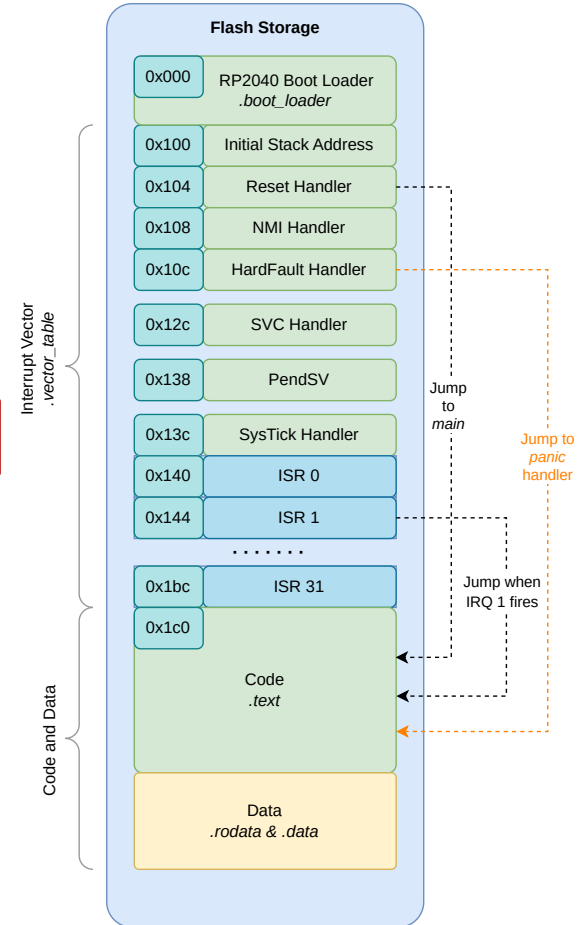

* drawing is not at scale, code and data are significantly greater than the interrupt vector



Boot

The RP2350 boot process

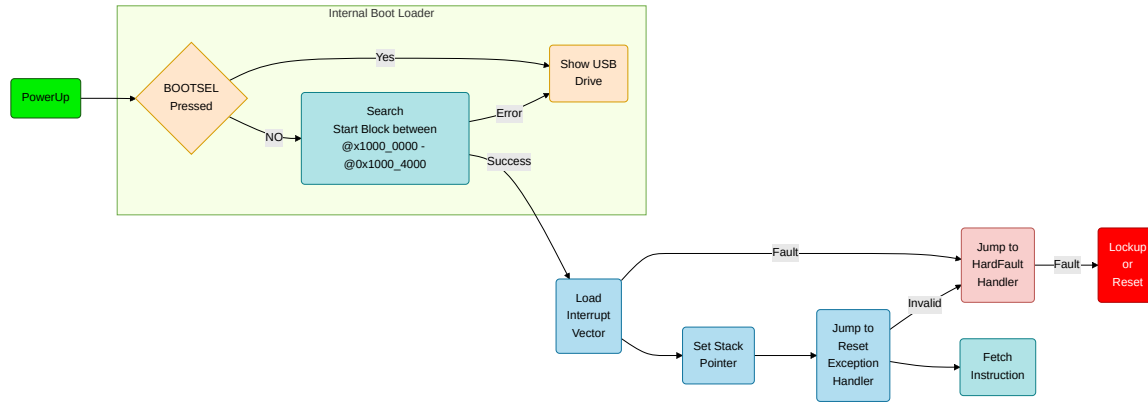

The internal boot loader cannot be overwritten and assures that bricking the device is difficult.

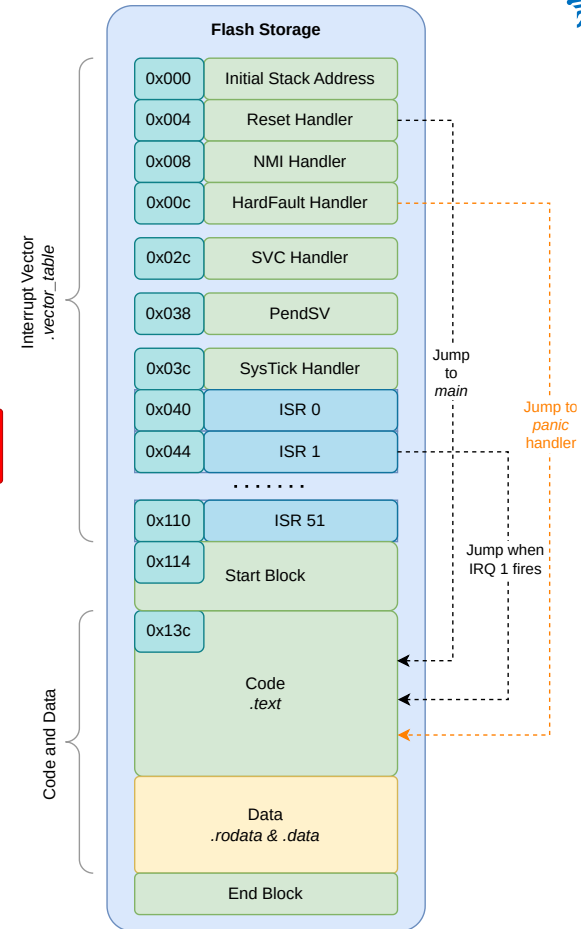

* drawing is not at scale, code and data are significantly greater than the interrupt vector



Set Fault Handler

bare metal, pac or embassy-rs

```
// defined by the cortex-m-rt crate
pub struct ExceptionFrame {
    r0: u32,
    r1: u32,
    r2: u32,
    r3: u32,
    r12: u32,
    lr: u32,
    pc: u32,
    xpsr: u32,
}
```

`HardFault` never returns

```
1  #[exception]
2  unsafe fn HardFault(_frame: &ExceptionFrame) -> ! {
3      panic!("HardFault {:?}", frame);
4  }
```



Set SysTick Handler

bare metal, PAC or embassy-rs

```
1  #[exception]
2  unsafe fn SysTick() {
3      // execute at a fixed interval
4  }
```



Set Interrupt Handlers

embassy-rs already defined the interrupts as it needs them

IRQ	Interrupt Source	IRQ	Interrupt Source	IRQ	Interrupt Source	IRQ	Interrupt Source	IRQ	Interrupt Source
0	TIMER_IRQ_0	6	XIP_IRQ	12	DMA_IRQ_1	18	SPI0_IRQ	24	I2C1_IRQ
1	TIMER_IRQ_1	7	PIO0_IRQ_0	13	IO_IRQ_BANK0	19	SPI1_IRQ	25	RTC_IRQ
2	TIMER_IRQ_2	8	PIO0_IRQ_1	14	IO_IRQ_QSPI	20	UART0_IRQ		
3	TIMER_IRQ_3	9	PIO1_IRQ_0	15	SIO_IRQ_PROC0	21	UART1_IRQ		
4	PWM_IRQ_WRAP	10	PIO1_IRQ_1	16	SIO_IRQ_PROC1	22	ADC_IRQ_FIFO		
5	USBCTRL_IRQ	11	DMA_IRQ_0	17	CLOCKS_IRQ	23	I2C0_IRQ		

```
1 // The name of the function has to match the
2 // interrupt name defined by the
3 // *Peripheral Access Crate* (PAC)
4 unsafe fn IO_IRQ_BANK0() {
5     // so some work when a pin interrupt triggers
6 }
```



Use interrupts in embassy-rs

embassy-rs registers interrupt handlers and exposes a high level API

IRQ	Interrupt Source	IRQ	Interrupt Source	IRQ	Interrupt Source	IRQ	Interrupt Source	IRQ	Interrupt Source
0	TIMER_IRQ_0	6	XIP_IRQ	12	DMA_IRQ_1	18	SPI0_IRQ	24	I2C1_IRQ
1	TIMER_IRQ_1	7	PI0B_IRQ_0	13	IO_IRQ_BANK0	19	SPI1_IRQ	25	RTC_IRQ
2	TIMER_IRQ_2	8	PI0B_IRQ_1	14	IO_IRQ_QSPI	20	UART0_IRQ		
3	TIMER_IRQ_3	9	PI01_IRQ_0	15	SIO_IRQ_PROC0	21	UART1_IRQ		
4	PWM_IRQ_WRAP	10	PI01_IRQ_1	16	SIO_IRQ_PROC1	22	ADC_IRQ_FIFO		
5	USBCtrl_IRQ	11	DMA_IRQ_0	17	CLOCKS_IRQ	23	I2C0_IRQ		

```
1  #[embassy_executor::main]
2  async fn main(_spawner: Spawner) {
3      let p = embassy_rp::init(Default::default());
4      let mut button = Input::new(p.PIN_20, Pull::None);
5
6      loop {
7          info!("Waiting for the button press");
8
9          // waits for interrupt (sent by button)
10         // IO_IRQ_BANK0
11         button.wait_for_high().await;
12
13         info!("Button was pressed");
14     }
15 }
```



Conclusion

we talked about

- Exceptions
- Interrupts
- How the RP2040 and RP2350 boot and load the software