



I2C & USB 2.0

Lecture 6



I2C & USB 2.0

used by RP2040 & STM32U545RE

- Buses
 - Inter-Integrated Circuit
 - Universal Serial Bus v2.0

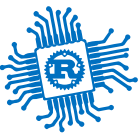

I2C

Inter-Integrated Circuit

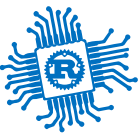

Bibliography

for this section

1. **Raspberry Pi Ltd**, *RP2350 Datasheet*
 - Chapter 12 - *Peripherals*
 - Chapter 12.2 - *I2C*
2. **STMicroelectronics**, *STM32U545RE Reference Manual*
 - Chapter 65 - *Inter integrated circuit interface*
3. **Paul Denisowski**, *Understanding I2C*

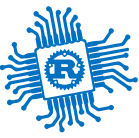

I2C

a.k.a *I square C*

- Used for communication between integrated circuits
- Sensors usually expose an *SPI* and an *I2C* interface
- Two device types:
 - *controller* (master) - initiates the communication (usually MCU)
 - *target* (slave) - receive and transmit data when the *controller* requests (usually the sensor)

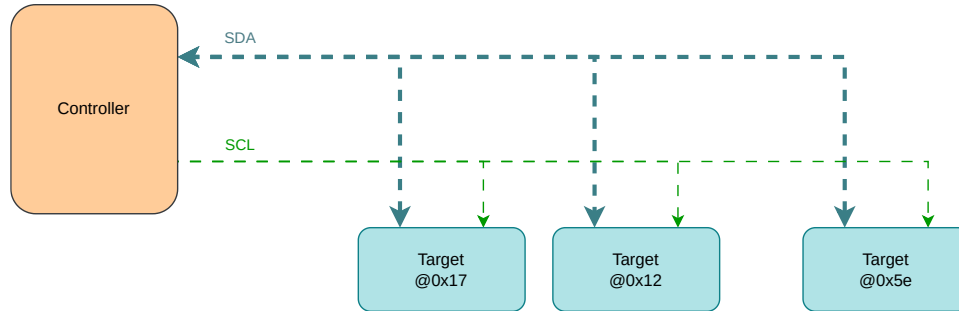



Wires & Addresses

- **SDA** - Serial **D**Ata line - carries data from the **controller** to the **target** or from the **target** to the **controller**
- **SCL** - Serial **C**Lock line - the clock signal generated by the **controller, targets**
 - *sample* data when the clock is *low*
 - *write* data to the bus only when the clock is *high*
- each *target* has a unique address of **7 bits** or **10 bits**
- wires are never driven with **LOW** or **HIGH**
 - are always *pull-up*, which is **HIGH**
 - devices *pull down* the lines to *write* **LOW**

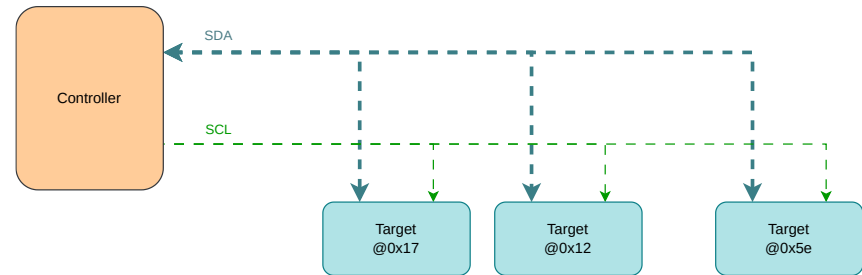
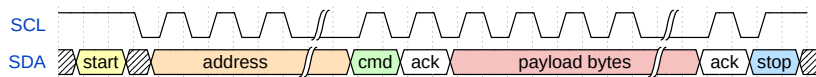



Transmission Example

7 bit address

1. **controller** issues a **START** condition
 - pulls the **SDA** line **LOW**
 - waits for ~ 1/2 clock periods and starts the clock
2. **controller** sends the address of the **target**
3. **controller** sends the command bit (**R/W**)
4. **target** sends **ACK / NACK** to **controller**
5. **controller** or **target** sends data (depends on **R/W**)
 - receives **ACK / NACK** after every byte
6. **controller** issues a **STOP** condition
 - stops the clock
 - pulls the **SDA** line **HIGH** while **CLK** is **HIGH**

Address Format

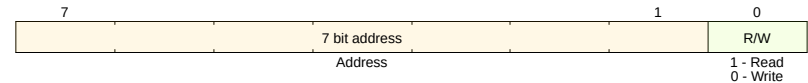

Transmission

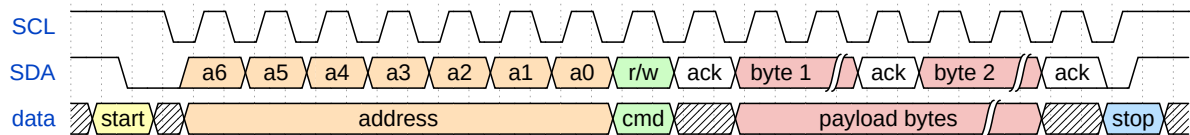



Transmission Example

10 bit address

1. **controller** issues a **START** condition
2. **controller** sends **11110** followed by the *upper address* of the **target**
3. **controller** sends the command bit (**R/W**)
4. **target** sends **ACK / NACK** to **controller**
5. **controller** sends the *lower address* of the **target**
6. **target** sends **ACK / NACK** to **controller**
7. **controller** or **target** sends data (depends on **R/W**)
 - receives **ACK / NACK** after every byte
8. **controller** issues a **STOP** condition

Address Format

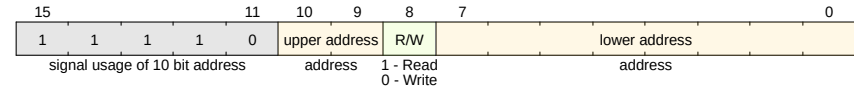

Transmission

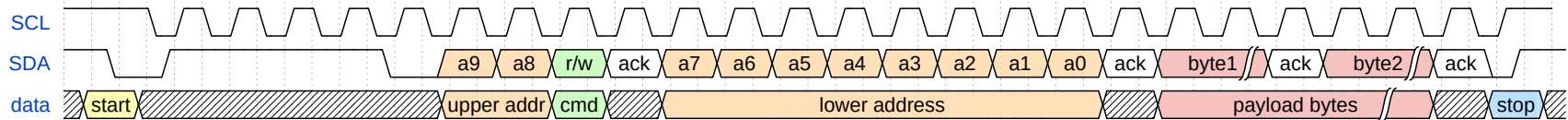

controller writes each bit when **CLK** is **LOW** , **target** samples every bit when **CLK** is **HIGH**

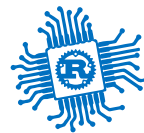

I2C Modes

Mode	Speed	Capacity	Drive	Direction
Standard mode (Sm)	100 kbit/s	400 pF	Open drain	Bidirectional
Fast mode (Fm)	400 kbit/s	400 pF	Open drain	Bidirectional
Fast mode plus (Fm+)	1 Mbit/s	550 pF	Open drain	Bidirectional
High-speed mode (Hs)	1.7 Mbit/s	400 pF	Open drain	Bidirectional
High-speed mode (Hs)	3.4 Mbit/s	100 pF	Open drain	Bidirectional
Ultra-fast mode (UFm)	5 Mbit/s	?	Push-pull	Unidirectional



Facts

Transmission	<i>half duplex</i>	data must be sent in one direction at one time
Clock	<i>synchronized</i>	the controller and target use the same clock, there is no need for clock synchronization
Wires	<i>SDA / SCL</i>	the same read and write wire and a clock wire
Devices	<i>1 controller several targets</i>	a receiver and a transmitter
Speed	<i>5 Mbit/s</i>	usually 100 Kbit/s, 400 Kbit/s and 1 Mbit/s



Usage

- sensors
- small displays
- RP2350 has two I2C devices
- STM32U545RE has four I2C devices

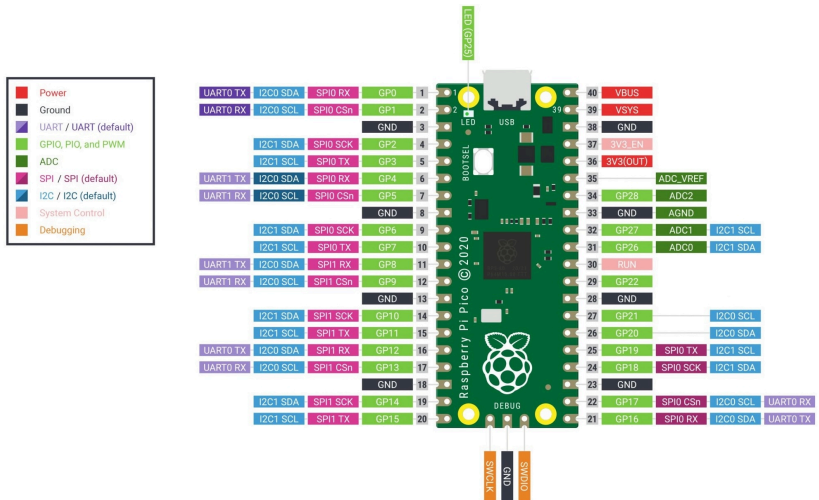

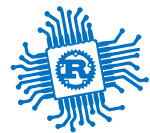

Embassy API

for RP2350, synchronous

```
pub struct Config {  
    /// Frequency.  
    pub frequency: u32,  
}
```

```
pub enum ConfigError {  
    /// Max i2c speed is 1MHz  
    FrequencyTooHigh,  
    ClockTooSlow,  
    ClockTooFast,  
}
```

```
pub enum Error {  
    Abort(AbortReason),  
    InvalidReadBufferLength,  
    InvalidWriteBufferLength,  
    AddressOutOfRange(u16),  
    AddressReserved(u16),  
}
```

```
1 use embassy_rp::i2c::Config as I2cConfig;  
2  
3 let sda = p.PIN_14;  
4 let scl = p.PIN_15;  
5 let mut i2c = i2c::I2c::new_blocking(p.I2C1, scl, sda, I2cConfig::default());  
6  
7 let tx_buf = [0x90];  
8 i2c.write(0x5e, &tx_buf).unwrap();  
9  
10 let mut rx_buf = [0x00u8; 7];  
11 i2c.read(0x5e, &mut rx_buf).unwrap();  
12  
13 i2c.write_read(0x5e, &tx_buf, &mut rx_buf).unwrap();
```

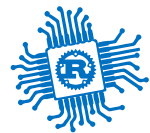

Embassy API

for STM32U545RE, synchronous

```
pub struct Config {  
    pub frequency: Hertz,  
    pub gpio_speed: Speed,  
    pub sda_pullup: bool,  
    pub scl_pullup: bool,  
    pub timeout: Duration,  
}
```

```
pub enum Error {  
    Bus, Arbitration,  
    Nack, Timeout,  
    Crc, Overrun,  
    ZeroLengthTransfer,  
}
```

```
1 use embassy_stm32::i2c::Config as I2cConfig;  
2  
3 let sda = p.PB7;  
4 let scl = p.PB6;  
5 let mut i2c = i2c::I2c::new_blocking(p.I2C1, scl, sda, I2cConfig::default());  
6  
7 let tx_buf = [0x90];  
8 i2c.blocking_write(0x5e, &tx_buf).unwrap();  
9  
10 let mut rx_buf = [0x00u8; 7];  
11 i2c.blocking_read(0x5e, &mut rx_buf).unwrap();  
12  
13 i2c.blocking_write_read(0x5e, &tx_buf, &mut rx_buf).unwrap();
```



Embassy API

for RP2350, asynchronous

```
1 use embassy_rp::i2c::Config as I2cConfig;
2
3 bind_interrupts!(struct Irqs {
4     I2C1_IRQ => InterruptHandler<I2C1>;
5 });
6
7 let sda = p.PIN_14;
8 let scl = p.PIN_15;
9 let mut i2c = i2c::I2c::new_async(p.I2C1, scl, sda, Irqs, I2cConfig::default());
10
11 let tx_buf = [0x90];
12 i2c.write(0x5e, &tx_buf).await.unwrap();
13
14 let mut rx_buf = [0x00u8; 7];
15 i2c.read(0x5e, &mut rx_buf).await.unwrap();
16
17 i2c.write_read(0x5e, &tx_buf, &mut rx_buf).await.unwrap();
```



Embassy API

for STM32U545RE, asynchronous

```
1 use embassy_rp::i2c::Config as I2cConfig;
2
3 bind_interrupts!(struct Irqs {
4     I2C1_EV => i2c::EventInterruptHandler<I2C1>;
5     I2C1_ER => i2c::ErrorInterruptHandler<I2C1>;
6 });
7
8 let sda = p.PB7;
9 let scl = p.PB6;
10 let mut i2c = I2c::new(p.I2C1, p.PB6, p.PB7, Irqs, p.GPDMA1_CH0, p.GPDMA1_CH1, Default::default());
11
12 let tx_buf = [0x90];
13 i2c.write(0x5e, &tx_buf).await.unwrap();
14
15 let mut rx_buf = [0x00u8; 7];
16 i2c.read(0x5e, &mut rx_buf).await.unwrap();
17
18 i2c.write_read(0x5e, &tx_buf, &mut rx_buf).await.unwrap();
```

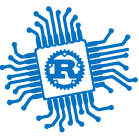

Sensors

Analog and Digital Sensors



Bibliography

for this section

BOSCH, *BMP280 Digital Pressure Sensor*

- Chapter 3 - *Functional Description*
- Chapter 4 - *Global memory map and register description*
- Chapter 5 - *Digital Interfaces*
 - Subchapter 5.2 - *I2C Interface*

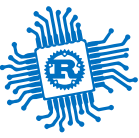

Sensors

analog and digital

Analog

- only the transducer (the analog sensor)
- outputs (usually) voltage
- requires:
 - an ADC to be read
 - cleaning up the noise

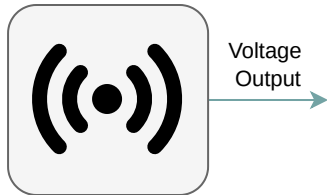

Digital

- consists of:
 - a transducer (the analog sensor)
 - an ADC
 - an MCU for cleaning up the noise
- outputs data using a digital bus

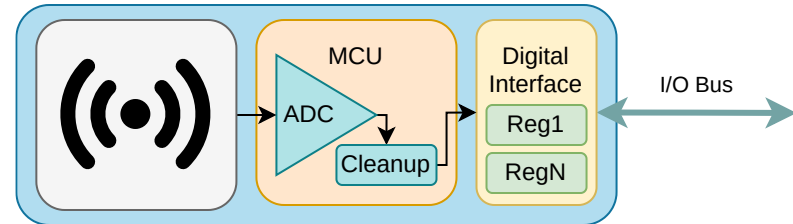

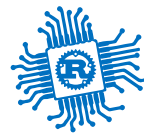

BMP280 Digital Pressure Sensor

schematics

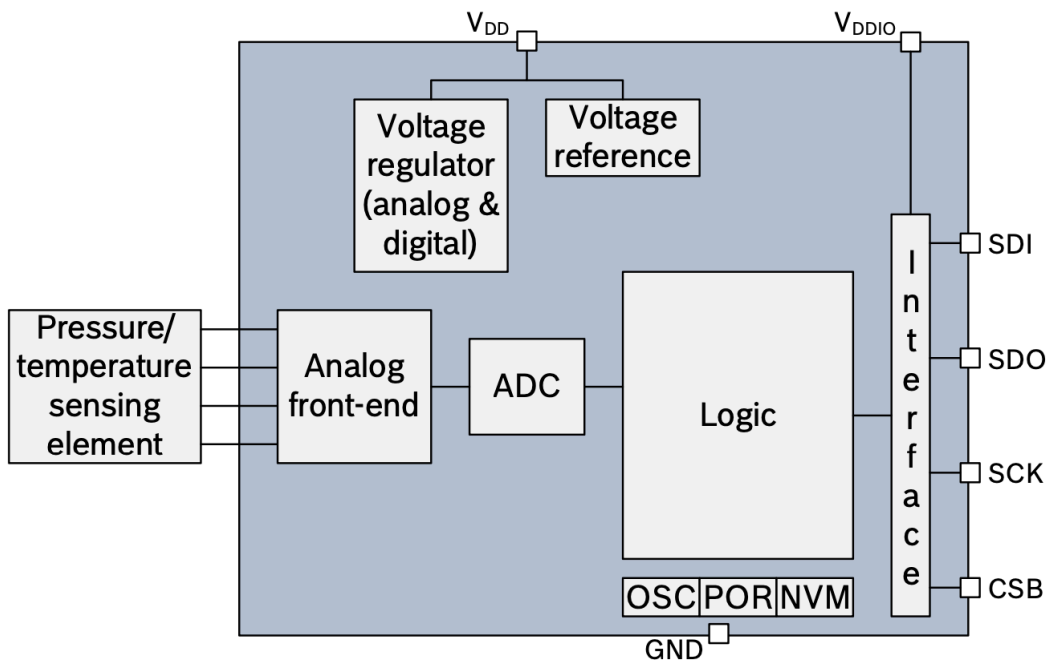

[Datasheet](#)

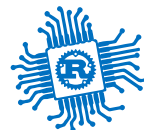

BMP280 Digital Pressure Sensor

registers map

Register Name	Address	bit7	bit6	bit5	bit4	bit3	bit2	bit1	bit0	Reset state	
temp_xlsb	0xFC	temp_xlsb<7:4>				0	0	0	0	0x00	
temp_lsb	0xFB	temp_lsb<7:0>									0x00
temp_msb	0xFA	temp_msb<7:0>									0x80
press_xlsb	0xF9	press_xlsb<7:4>				0	0	0	0	0x00	
press_lsb	0xF8	press_lsb<7:0>									0x00
press_msb	0xF7	press_msb<7:0>									0x80
config	0xF5	t_sb[2:0]			filter[2:0]			spi3w_en[0]		0x00	
ctrl_meas	0xF4	osrs_t[2:0]			osrs_p[2:0]			mode[1:0]		0x00	
status	0xF3					measuring[0]		im_update[0]		0x00	
reset	0xE0	reset[7:0]									0x00
id	0xD0	chip_id[7:0]									0x58
calib25...calib00	0xA1...0x88	calibration data									individual

Registers:	Reserved registers	Calibration data	Control registers	Data registers	Status registers	Revision	Reset
Type:	do not write	read only	read / write	read only	read only	read only	write only

Datasheet

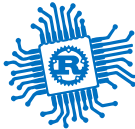

Reading from a digital sensor

using synchronous/asynchronous I2C to read the `pressure_lsb` register of BMP280

```
1  const DEVICE_ADDR: u8 = 0x77;
2  const REG_ADDR: u8 = 0xf8;
3
4  let mut buf = [0x00u8];
5
6  i2c.blocking_write_read(
7      DEVICE_ADDR, &[REG_ADDR], &mut buf
8  ).unwrap();
9
10 // use the value
11 let pressure_lsb = buf[1];
```

```
1  const DEVICE_ADDR: u8 = 0x77;
2  const REG_ADDR: u8 = 0xf8;
3
4  let mut buf = [0x00u8];
5
6  i2c.write_read(
7      DEVICE_ADDR, &[REG_ADDR], &mut buf
8  ).await.unwrap();
9
10 // use the value
11 let pressure_lsb = buf[1];
```

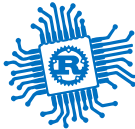

Writing to a digital sensor

using synchronous/asynchronous I2C to set up the `ctrl_meas` register of the BMP280 sensor

```
1  const DEVICE_ADDR: u8 = 0x77;
2  const REG_ADDR: u8 = 0xf4;
3
4  // see subchapters 3.3.2, 3.3.1 and 3.6
5  let value = 0b100_010_11;
6
7  let buf = [REG_ADDR, value];
8  i2c.blocking_write(DEVICE_ADDR, &buf).unwrap();
```

```
1  const DEVICE_ADDR: u8 = 0x77;
2  const REG_ADDR: u8 = 0xf4;
3
4  // see subchapters 3.3.2, 3.3.1 and 3.6
5  let value = 0b100_010_11;
6
7  let buf = [REG_ADDR, value];
8  i2c.write(DEVICE_ADDR, &buf).await.unwrap();
```

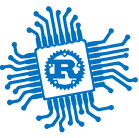

USB 2.0

Universal Serial Bus

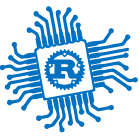

Universal Serial Bus

2.0

- Used for communication between a host and several devices that each provide functions
- Two modes:
 - *host* - initiates the communication (usually a computer)
 - *device* - receives and transmits data when the *host* requests it
- each device has a 7 bit address assigned upon connect
 - maximum 127 devices connected to a USB host
- devices are interconnected using *hubs*
- USB devices tree

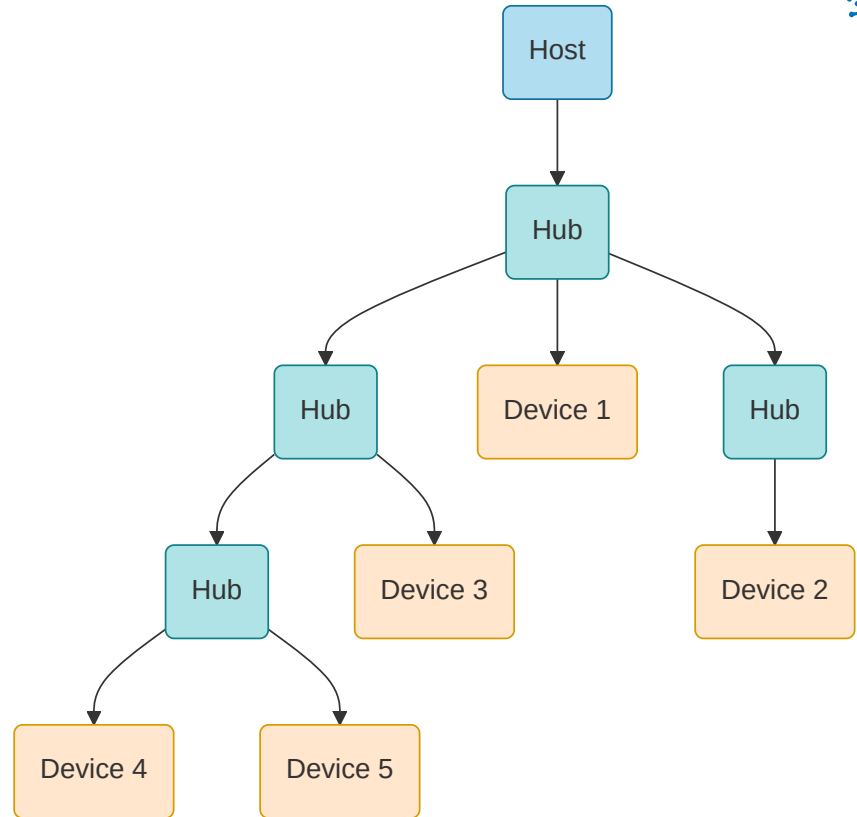

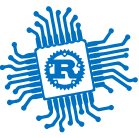

Bibliography

for this section

1. **Raspberry Pi Ltd**, *RP2350 Datasheet*
 - Chapter 12 - *Peripherals*
 - Chapter 12.7 - *USB*
2. **STMicroelectronics**, *STM32U545RE Reference Manual*
 - Chapter 71 - *Universal serial bus full-speed host/device interface (USB)*
3. **BeyondLogic**, *USB in a NutShell*
4. **Ben Eater**, *How does a USB keyboard work?*
5. **Ben Eater**, *How does USB device discovery work?*
6. *USB Made Simple*

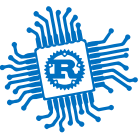

USB

- can work as **host** or **device**, but not at the same time
- uses a differential line for transmission
- uses a 48 MHz clock
- maximum 16 endpoints (buffers)
 - *IN* - from **device** to **host**
 - *OUT* - from **host** to **device**
- endpoints 0 IN and OUT are used for control

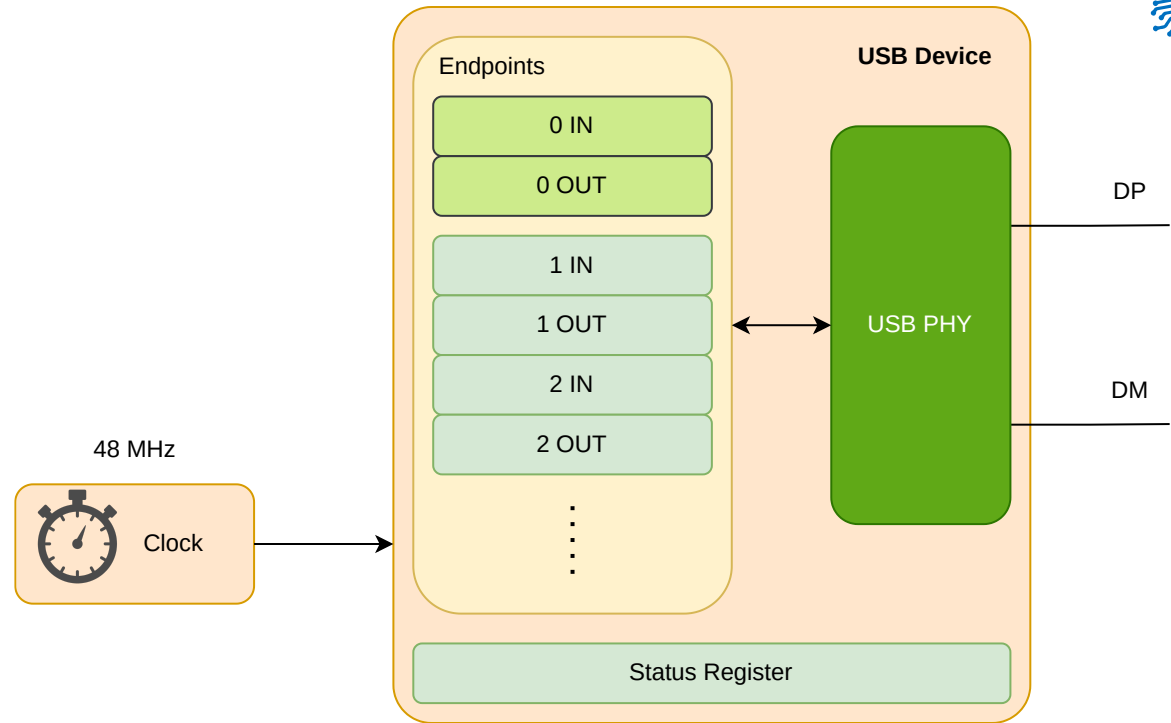



USB Packet

the smallest element of data transmission

Token

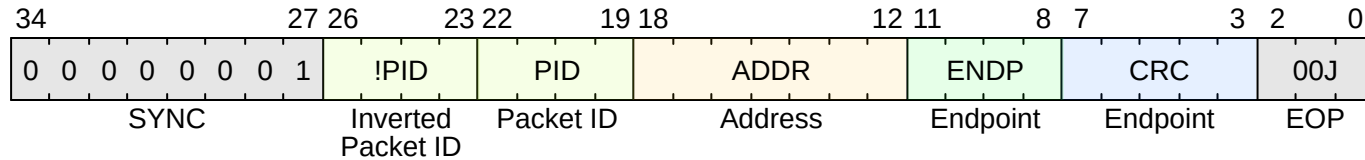

Data

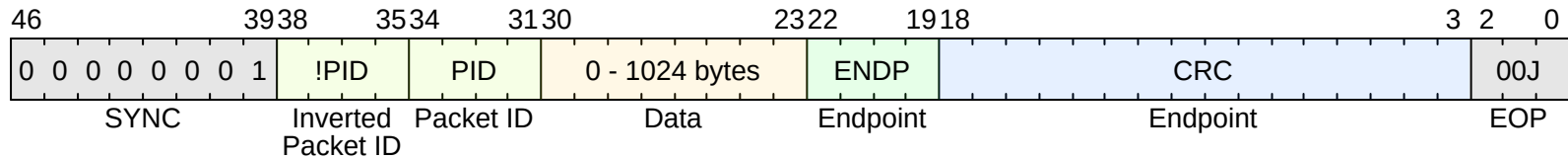

Handshake

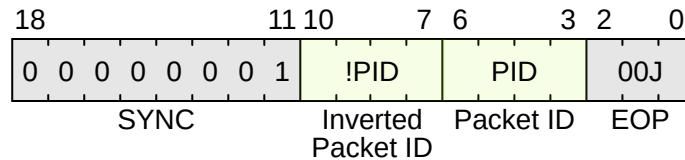



Token Packet

usually asks for a data transmission

Type	PID	Description
<i>OUT</i>	0001	host wants to transmit data to the device
<i>IN</i>	1001	host wants to receive data from the device
<i>SETUP</i>	1101	host wants to setup the device

Address: ADDR : ENDP

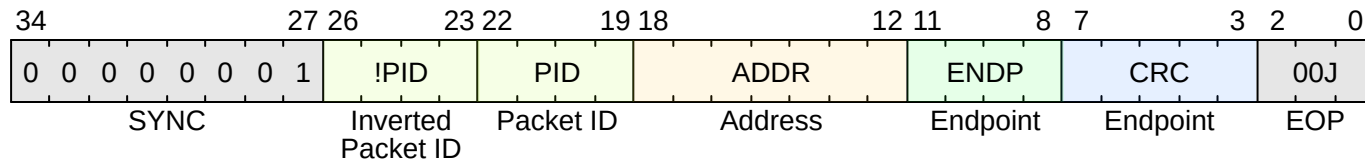



Data Packet

transmits data

Type	PID	Description
<i>DATA0</i>	0011	the data packet is the first one or follows after a <i>DATA1</i> packet
<i>DATA1</i>	1011	the data packet follows after a <i>DATA0</i> packet

Data can be between 0 and 1024 bytes

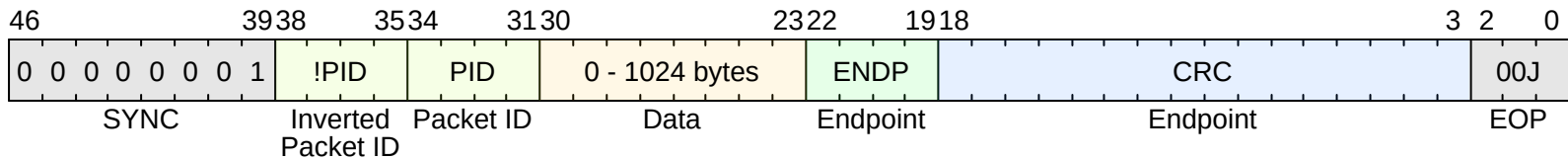



Handshake Packet

acknowledges data

Type	PID	Description
<i>ACK</i>	0010	data has been successfully received
<i>NACK</i>	1010	data has not been successfully received
<i>STALL</i>	1110	the device has an error

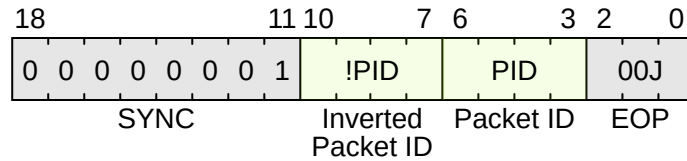

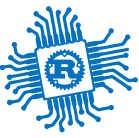

Transmission Modes

- *Control* - used for configuration
- *Isochronous* - used for high bandwidth, best effort
- *Bulk* - used for low bandwidth, stream
- *Interrupt* - used for low bandwidth, guaranteed latency

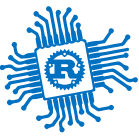

Control

used to control a device - ask for data

Setup - send a command (*GET_DESCRIPTOR*, ...)

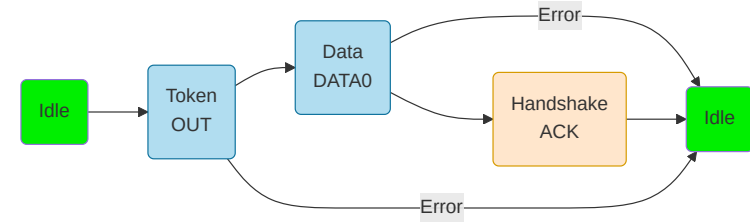
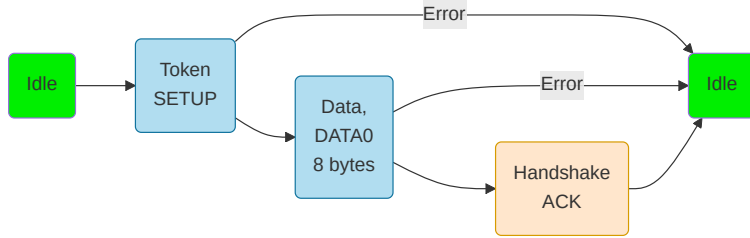

...

Status - report the status to the host

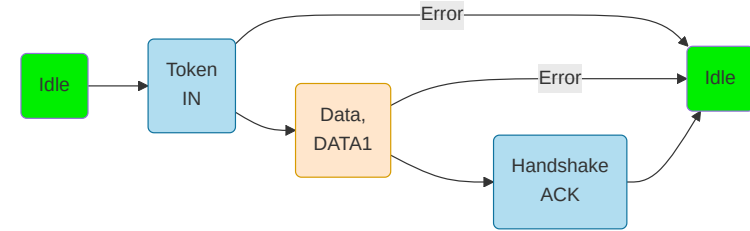
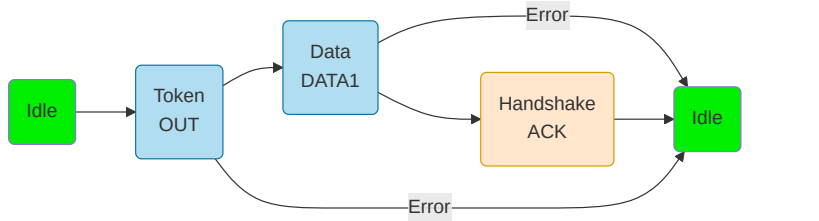

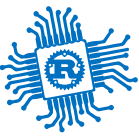

Control

used to control a device - send data

Setup - send a command (*SET_ADDRESS, ...*)

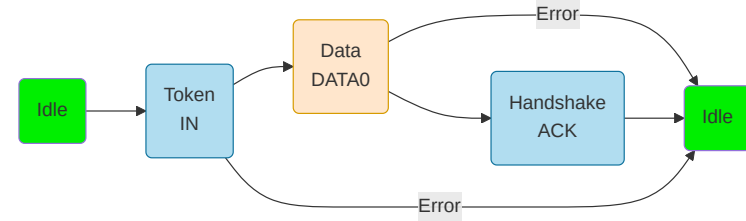
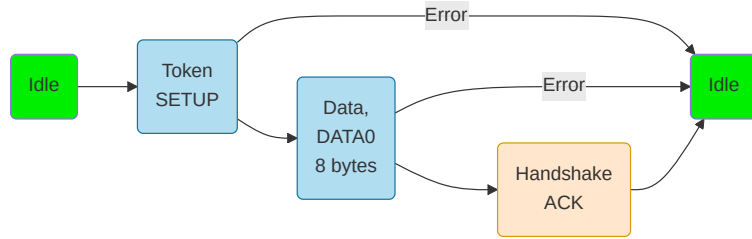

...

Status - report the status to the device

Data - *optional* several transfers, device transfers the requested data

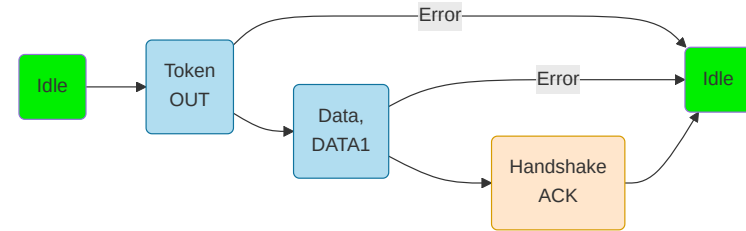
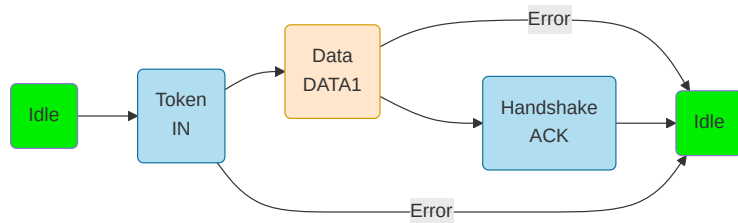

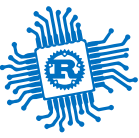

Isochronous

fast but not reliable transfer

- has a guaranteed bandwidth
- allows data loss
- used for functions like streaming where losing a packet has a minimal impact

OUT - transfer data from the host to the device

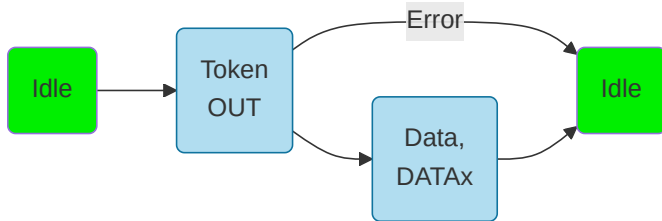

IN - transfer data from the device to the host

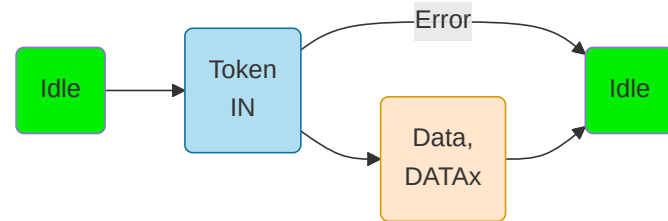

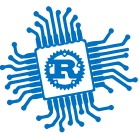

Bulk

slow, but reliable transfer

- does not have a guaranteed bandwidth
- does not allow data loss
- used for large data transfers where losing packets is not permitted

OUT - transfer data from the host to the device

IN - transfer data from the device to the host

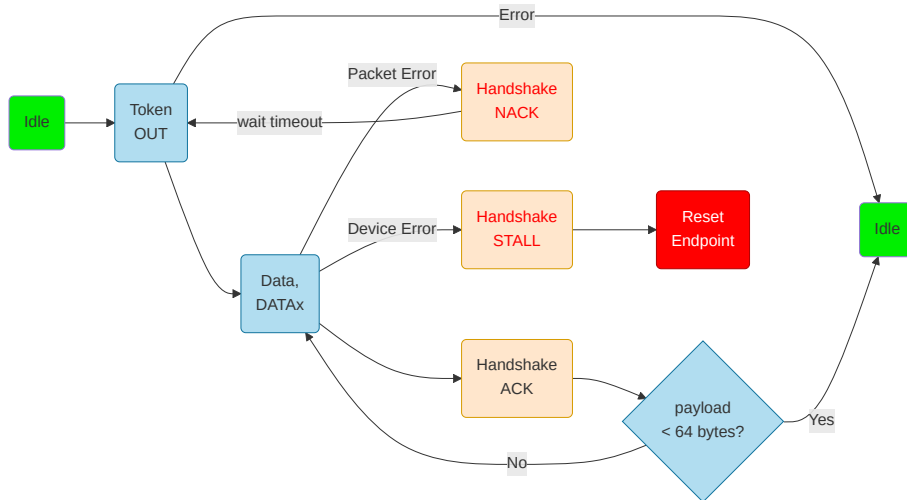

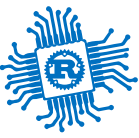

Interrupt

transfer data at a minimum time interval

- the endpoint descriptor asks the host start an interrupt transfer at a time interval
- used for sending and receiving data at certain intervals

OUT - transfer data from the host to the device

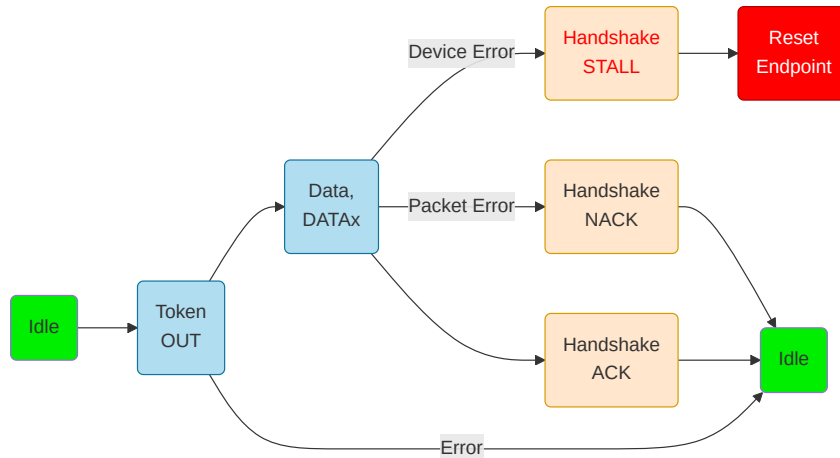

IN - transfer data from the device to the host

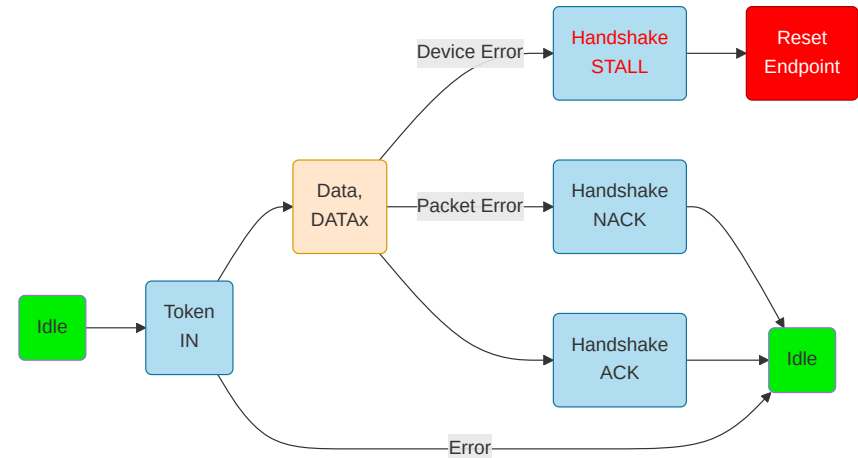

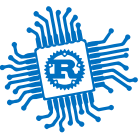

Device Organization

configuration, interfaces, endpoints

- a *device* can have multiple *configurations*
 - for instance different functionality based on power consumption
- a *configuration* has multiple *interfaces*
 - a device can perform multiple functions
 - Debugger
 - Serial Port
- each *interface* has *alternate settings* with multiple *endpoints* attached
 - endpoints are used for data transfer
 - maximum 16 endpoints, can be configured IN and OUT
- the device reports the descriptors in this order

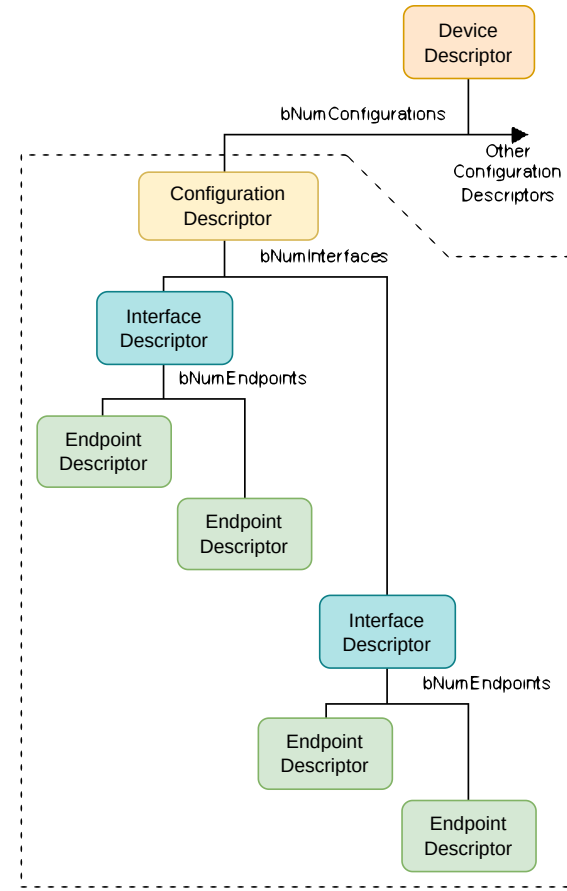



Connection

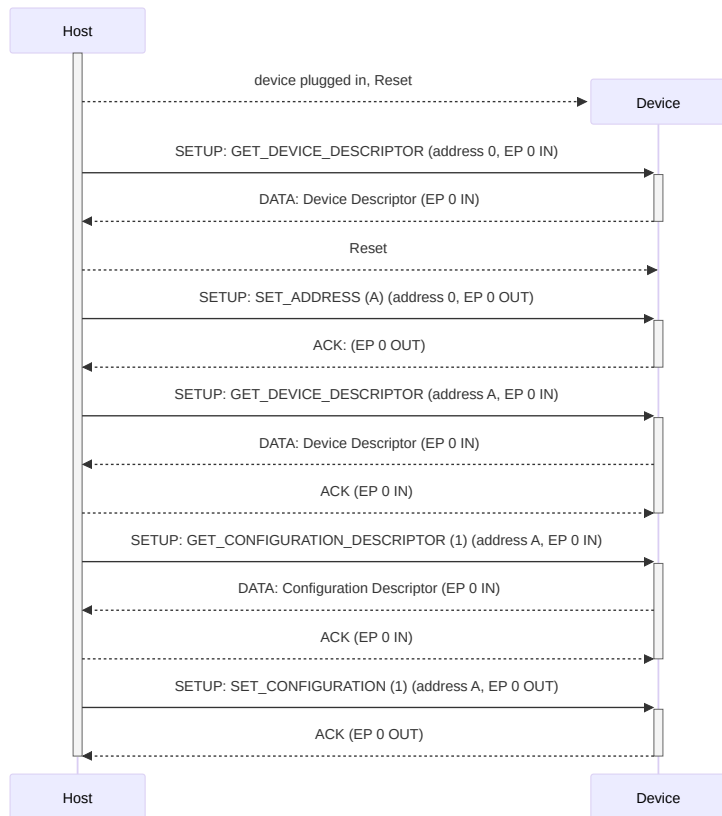

Token SETUP Packet

The DATA packet of the SETUP Control Transfer

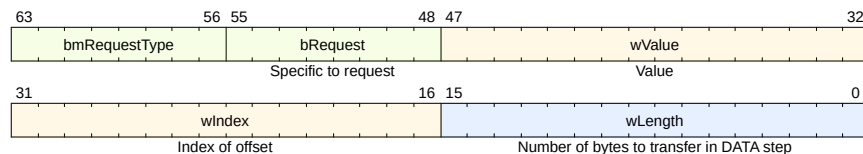

bmRequestType field

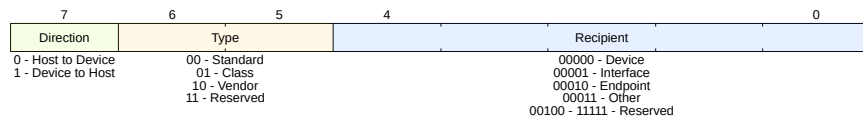

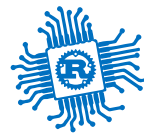

Device Classes

predefined devices types

Device Class Code	Class Name	Description
0x00	Device Class	Device class-specific; the class code is assigned by the device.
0x01	Audio	Audio devices (e.g., audio interfaces, speakers, microphones).
0x02	Communications and CDC Control	Devices related to communication (e.g., modems, network adapters).
0x03	HID (Human Interface Device)	Devices like keyboards, mice, and other human interface devices.
0x05	Physical Interface Device (PID)	Devices that require physical input/output (e.g., game controllers).
0x06	Image	Image devices such as digital cameras and scanners.
0x07	Printer	Devices for printing (e.g., printers).
0x08	Mass Storage	Mass storage devices (e.g., USB flash drives, external hard drives).
0x0A	Still Image Capture Device	Devices for still image capture (e.g., digital cameras).
0x0B	Smart Card	Smart card readers and related devices.
0x0D	Content Security	Devices for content protection (e.g., video players).
0x0E	Video	Video devices (e.g., webcams, video capture devices).
0x0F	Personal Healthcare	Healthcare devices (e.g., thermometers, blood pressure monitors).
0x10	Audio/Video	Devices with combined audio/video functions.
0x11	Health Device	Devices used in health-related monitoring.
0x12	Diagnostic Device	Devices for diagnostics or test instruments.
0xFF	Vendor Specific	Vendor-specific devices (class code not assigned by USB standard).

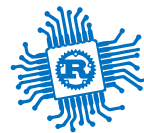

Device Descriptor

describes the whole device

Field	Value	Description
<i>bLength</i>	18	Descriptor length in bytes.
<i>bDescriptorType</i>	1	Descriptor type (1 = Device Descriptor).
<i>bcdUSB</i>	0x0200	USB specification release number (2.0).
<i>bDeviceClass</i>	0xFF	Device class (0xFF = Vendor Specific).
<i>bDeviceSubClass</i>	0	Device subclass (0 = defined by the interface).
<i>bDeviceProtocol</i>	0	Device protocol (0 = defined by the interface).
<i>bMaxPacketSize0</i>	64	Maximum packet size for endpoint 0 (64 bytes).
<i>idVendor</i>	0xCODE	Vendor ID (example: 0xCODE).
<i>idProduct</i>	0xCAFE	Product ID (example: 0xCAFE).
<i>bcdDevice</i>	0x0100	Device release number (example: 1.0).
<i>iManufacturer</i>	1	Index of the string descriptor for the manufacturer.
<i>iProduct</i>	2	Index of the string descriptor for the product.
<i>iSerialNumber</i>	3	Index of the string descriptor for the serial number.
<i>bNumConfigurations</i>	1	Number of configurations supported by the device.



Configuration Descriptor

one of the configurations

Field	Value	Description
<i>bLength</i>	9	Descriptor length in bytes (always 9 for configuration descriptor).
<i>bDescriptorType</i>	2	Descriptor type (2 = Configuration Descriptor).
<i>wTotalLength</i>	0x0022	Total length of data returned for this configuration (including all descriptors).
<i>bNumInterfaces</i>	1	Number of interfaces supported by this configuration.
<i>bConfigurationValue</i>	1	Value to select this configuration.
<i>iConfiguration</i>	4	Index of the string descriptor describing the configuration.
<i>bmAttributes</i>	0x80	Configuration characteristics (bus-powered, no remote wake-up).
<i>bMaxPower</i>	50	Maximum power consumption (in 2mA units, so 50 means 100mA).

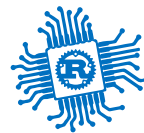

Interface Descriptor

Field	Value	Description
<i>bLength</i>	9	Descriptor length in bytes (always 9 for interface descriptor).
<i>bDescriptorType</i>	4	Descriptor type (4 = Interface Descriptor).
<i>bInterfaceNumber</i>	0	Number of this interface (starting from 0).
<i>bAlternateSetting</i>	0	Alternate setting (0 = default setting).
<i>bNumEndpoints</i>	1	Number of endpoints used by this interface.
<i>bInterfaceClass</i>	0xFF	Interface class (0xFF = Vendor Specific).
<i>bInterfaceSubClass</i>	0	Interface subclass (0 = vendor specific).
<i>bInterfaceProtocol</i>	0	Interface protocol (0 = vendor specific).
<i>iInterface</i>	5	Index of the string descriptor describing this interface.

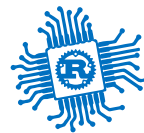

Endpoint Descriptor

Field	Value	Description
<i>bLength</i>	7	Descriptor length in bytes (always 7 for endpoint descriptor).
<i>bDescriptorType</i>	5	Descriptor type (5 = Endpoint Descriptor).
<i>bEndpointAddress</i>	0xb1_0000_001	Endpoint address (0x81): Bit 7 indicates IN direction (device to host), and Bits 0-3 indicate the endpoint number (1 in this case).
<i>bmAttributes</i>	0x02	Endpoint attributes (0x02 = Bulk endpoint).
<i>wMaxPacketSize</i>	64	Maximum packet size the endpoint can handle (64 bytes).
<i>bInterval</i>	0	Interval for polling (relevant for interrupt endpoints; 0 for others).

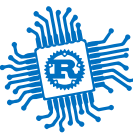

Strings Descriptor

String Descriptor for Configuration and Interface

Field	Value	Description
<i>bLength</i>	4	Descriptor length in bytes (always 4 for string descriptor header).
<i>bDescriptorType</i>	3	Descriptor type (3 = String Descriptor).
<i>bString</i>	0x09 0x55 0x53 0x42 0x20 0x43 0x6F 0x6E 0x66 0x69 0x67 0x20 0x31	UTF-16LE string encoding: "USB Config 1" .

Explanation: This string descriptor corresponds to **Configuration 1**. The string is encoded in **UTF-16LE** (little-endian). Each character is represented by two bytes.

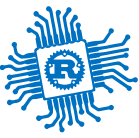

USB 1.0 and 2.0 Modes

Mode	Speed	Version
Low Speed	1.5 Mbit/s	1.0
Full Speed	12 Mbit/s	1.0
High Speed	480 Mbit/s	2.0

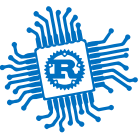

Facts

Transmission	<i>half duplex</i>	data must be sent in one direction at one time
Clock	<i>independent</i>	the host and the device must synchronize their clocks
Wires	<i>DP / DM</i>	data is sent in a differential way
Devices	<i>1 host several devices</i>	a receiver and a transmitter
Speed	<i>480 Mbit/s</i>	

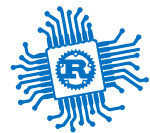

Embassy API

for RP2350 and STM32U545RE, setup the device

```
1 use embassy_stm32::usb::{Driver, InterruptHandler};
2 use embassy_usb::Config as UsbConfig;
3
4 bind_interrupts!(struct Irqs {
5     USB => InterruptHandler<USB>;
6 });
7
8 let mut config = UsbConfig::new(0xc0de, 0xcafe);
9 config.manufacturer = Some("Embassy");
10 config.product = Some("USB sender receiver");
11 config.serial_number = Some("12345678");
12 config.max_power = 100;
13 config.max_packet_size_0 = 64;
14
15 let driver = Driver::new(peripherals.USB, Irqs, peripherals.PA12, peripherals.PA11);
```

JP3 has to be moved to USB USER



Embassy API

for RP2350 and STM32U545RE, setup the descriptors

```
1 use embassy_usb::msos::{self, windows_version};
2 use embassy_usb::Builder;
3
4 // It needs some buffers for building the descriptors.
5 let mut config_descriptor = [0; 256];
6 let mut bos_descriptor = [0; 256];
7 let mut msos_descriptor = [0; 256];
8 let mut control_buf = [0; 64];
9
10 let mut builder = Builder::new(driver, config,
11     &mut config_descriptor, &mut bos_descriptor, &mut msos_descriptor, &mut control_buf,
12 );
13
14 // Required for Windows
15 const DEVICE_INTERFACE_GUIDS: &[&str] = &["{AFB9A6FB-30BA-44BC-9232-806CFC875321}"];
16 builder.msos_descriptor(windows_version::WIN8_1, 0);
17 builder.msos_feature(msos::CompatibleIdFeatureDescriptor::new("WINUSB", ""));
18 builder.msos_feature(msos::RegistryPropertyFeatureDescriptor::new(
19     "DeviceInterfaceGUIDs",
20     msos::PropertyData::RegMultiSz(DEVICE_INTERFACE_GUIDS),
21 ));
```

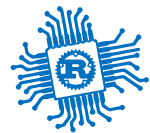

Embassy API

for RP2350 and STM32U545RE, setup the device's function and start

```
1 // Add a vendor-specific function (class 0xFF), and corresponding interface,  
2 // that uses our custom handler.  
3 let mut function = builder.function(0xFF, 0, 0);  
4 let mut interface = function.interface();  
5 let mut alt = interface.alt_setting(0xFF, 0, 0, None);  
6 let mut read_ep = alt.endpoint_bulk_out(64);  
7 let mut write_ep = alt.endpoint_bulk_in(64);  
8 drop(function);  
9  
10 // Build the builder.  
11 let mut usb = builder.build();  
12  
13 // Create the USB device handler  
14 let usb_run = usb.run();
```

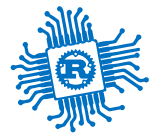

Embassy API

for RP2350 and STM32U545RE, use the USB device

```
1  let echo_run = async {
2    loop {
3      read_ep.wait_enabled().await;
4      info!("Connected");
5      loop {
6        let mut data = [0; 64];
7        match read_ep.read(&mut data).await {
8          Ok(n) => {
9            info!("Got bulk: {:a}", data[..n]);
10           // Echo back to the host:
11           write_ep.write(&data[..n]).await.ok();
12         }
13         Err(_) => break,
14       }
15     }
16     info!("Disconnected");
17   }
18 };
19
20 // Run everything concurrently.
21 // If we had made everything `static` above instead, we could do this using separate tasks instead.
22 join(usb_run, echo_run).await;
```



Host API

using nusb

```
1 use nusb::transfer::RequestBuffer;
2
3 const BULK_OUT_EP: u8 = 0x01;
4 const BULK_IN_EP: u8 = 0x81;
5
6 async fn main() {
7     let di = nusb::list_devices()
8         .unwrap()
9         .find(|d| d.vendor_id() == 0xc0de && d.product_id() == 0xcafe)
10        .expect("no device found");
11
12    let device = di.open().expect("error opening device");
13    let interface = device.claim_interface(0).expect("error claiming interface");
14
15    let result = interface.bulk_out(BULK_OUT_EP, b"hello world".into()).await;
16    println!("{result:?}");
17
18    let result = interface.bulk_in(BULK_IN_EP, RequestBuffer::new(64)).await;
19    println!("{result:?}");
20 }
```



Host API

using Python

```
1 import usb
2 import time
3
4 # Find the USB device
5 dev = usb.core.find(idVendor=0xc0de, idProduct=0xcafe)
6 if dev is None:
7     raise ValueError('Device not found')
8
9 dev.set_configuration() # Set the active configuration (this is usually required after device detection)
10
11 OUT_ENDPOINT = 0x01 # Usually 0x01 for OUT endpoint
12 IN_ENDPOINT = 0x81 # Usually 0x81 for IN endpoint (Endpoint 1, Direction IN)
13
14 data_to_send = b"Hello, USB Device!"
15
16 dev.write(OUT_ENDPOINT, data_to_send)
17 time.sleep(1) # Wait for a short time to ensure data is transferred
18
19 data_received = dev.read(IN_ENDPOINT, 64) # Read 64 bytes (adjust the size if needed)
20 print("Data received from device:", bytes(data_received))
21
22 usb.util.release_interface(dev, 0) # Release the device interface (optional, but good practice)
```

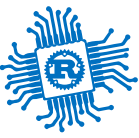

Conclusion

we talked about

- Buses
 - Inter-Integrated Circuit
 - Universal Serial Bus v2.0