



Memory Mapped IO used for GPIO

Lecture 2



Accessing Peripherals

- Memory Mapped I/O
 - GPIO Peripheral
- Embedded Rust Stack
- `embassy`

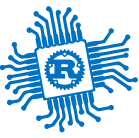

MMIO

Memory Mapped Input Output

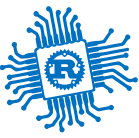

Bibliography

for this section

Joseph Yiu, *The Definitive Guide to ARM® Cortex®-M23 and Cortex-M33 Processors*

- Chapter 6 - *Memory system*
 - Section 6.1 - *Overview of the memory system*
 - Section 6.2 - *Memory map*
 - Section 6.11 - *Memory systems in microcontrollers*

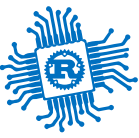

8 bit processor

a simple 8 bit processor with a text display

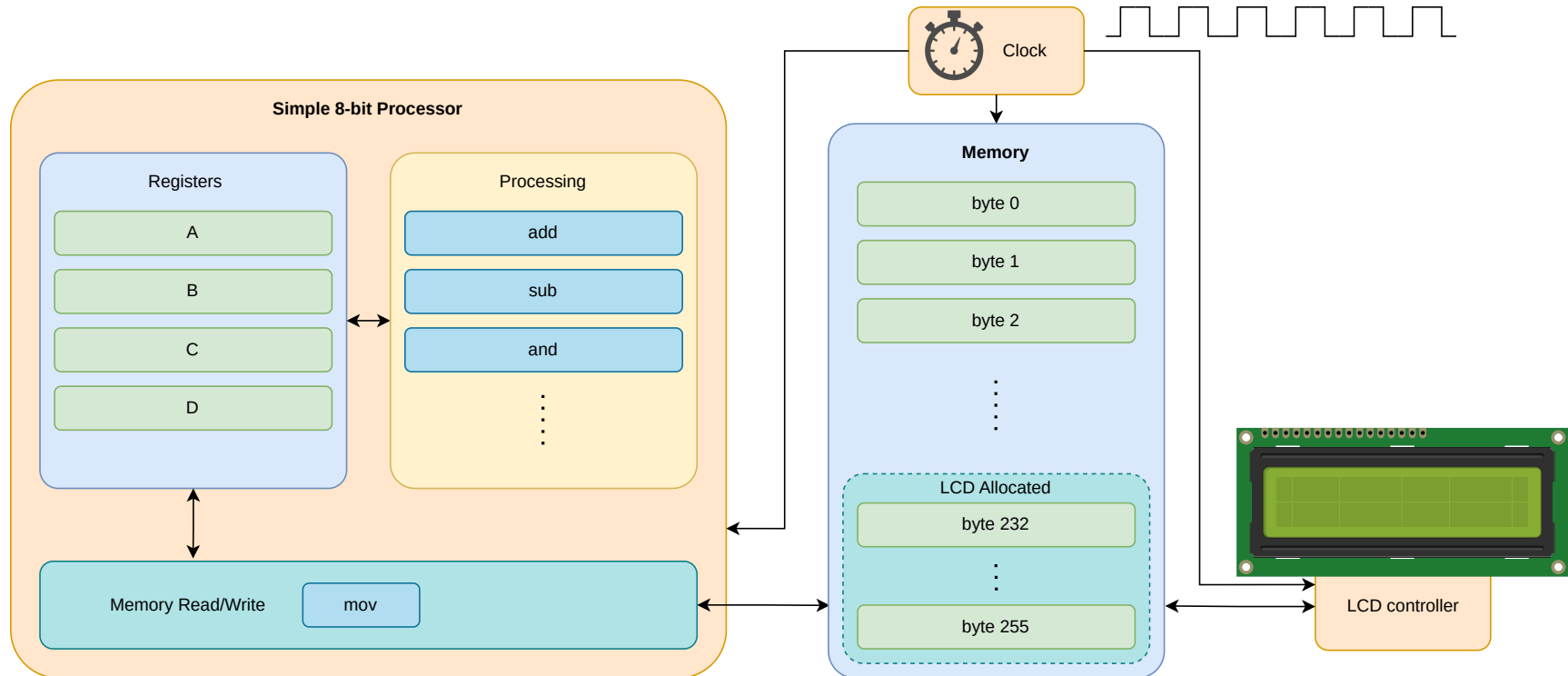

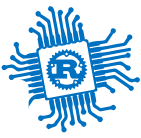

The Bus

example for RP2

1. **Memory Controller** asks for data transfer
2. **Internal Bus Routes** the request
 - to the *External Bus* or
 - to the *Internal Peripherals*
3. **External Bus Routes** the request based on the *Address Mapping Table*
 1. to **RAM**
 2. to **Flash**
 3. to an **External Peripheral**

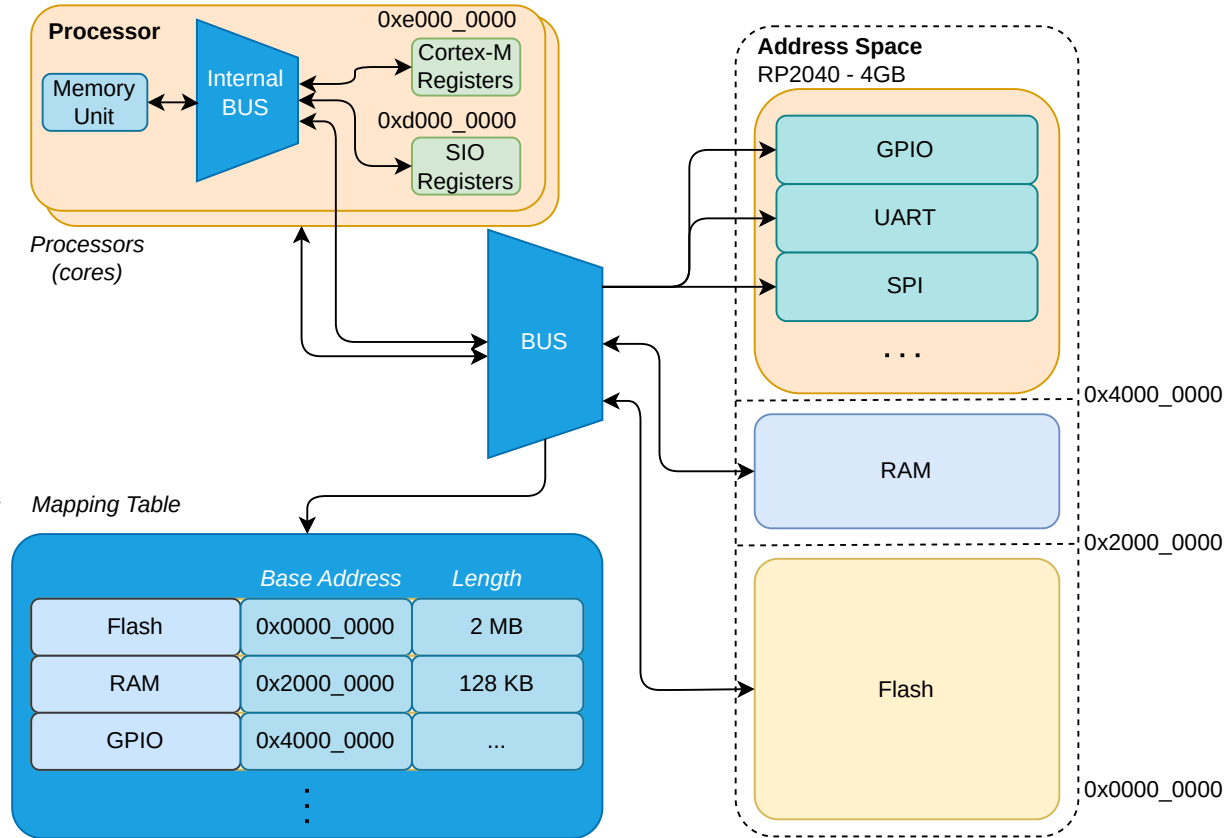

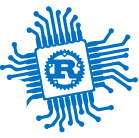

The Bus

example for STM32U545RE

1. **Memory Controller** asks for data transfer
2. **Internal Bus Routes** the request
 - to the *External Bus* or
 - to the *Internal Peripherals*
3. **External Bus Routes** the request based on the *Address Mapping Table*
 1. to **RAM**
 2. to **Flash**
 3. to an **External Peripheral**

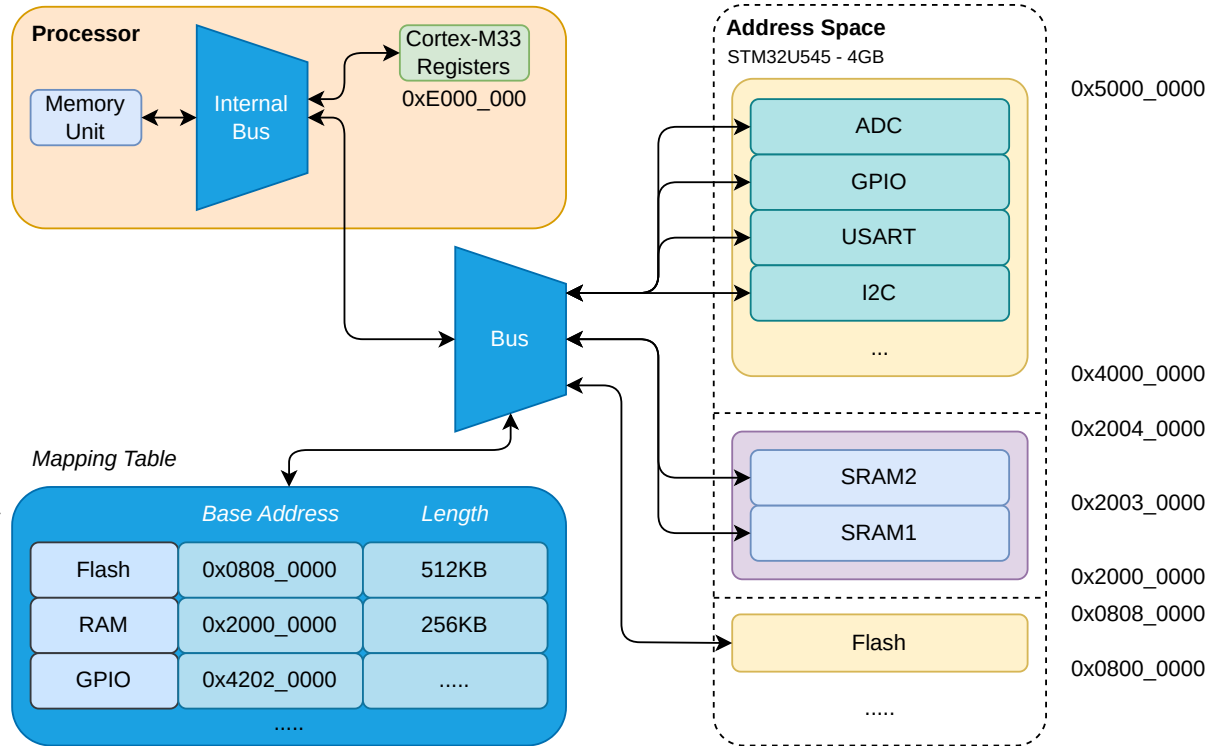



Cortex-M33 Memory Layout

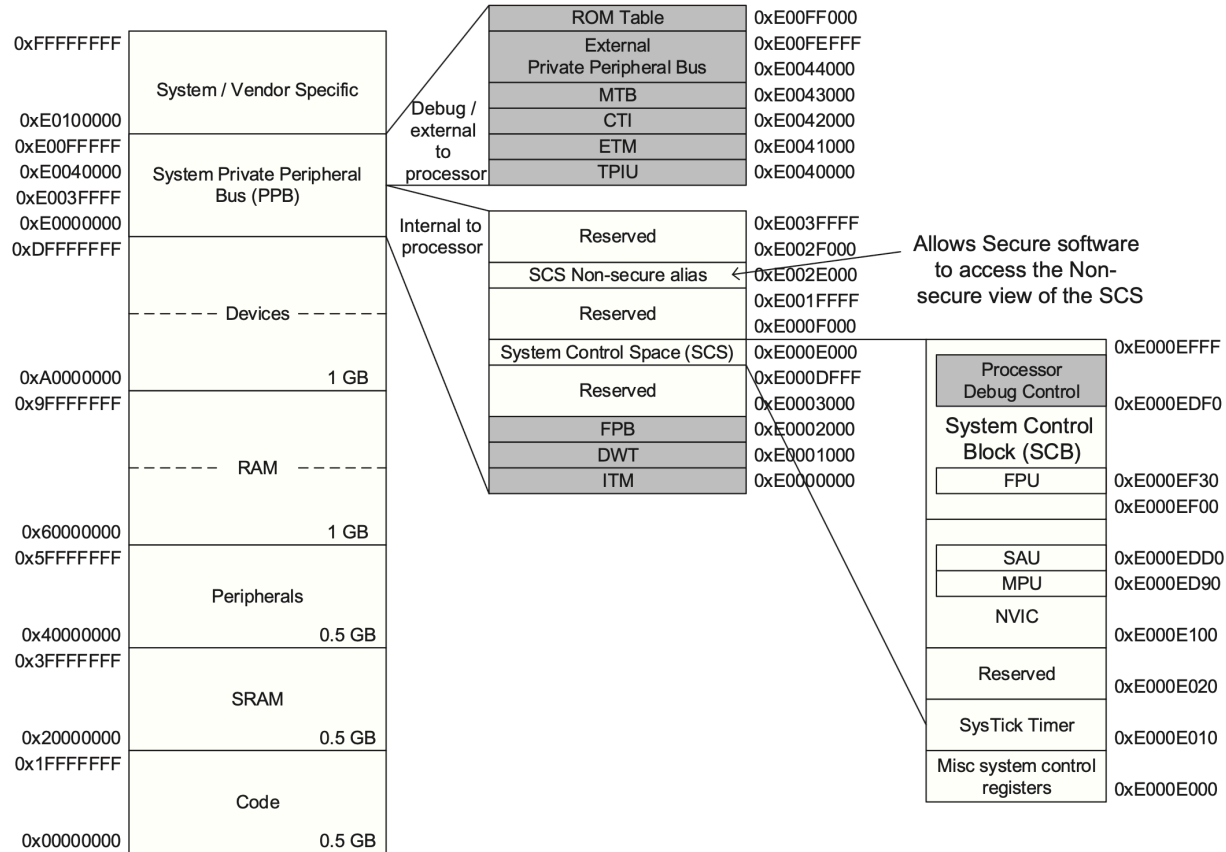

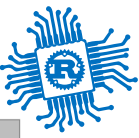

System Control Registers

Cortex-M0+^[1] SCR Peripheral @0xe000_0000

Compute the actual address

$$e000_0000_{(16)} + register_offset$$

Register Examples:

- **SYST_CSR: 0xe000_e010** ($0xe000_0000 + 0xe010$)
- **CPUID: 0xe000_ed00** ($0xe000_0000 + 0xed00$)

```
const SYS_CTRL_ADDR: usize = 0xe000_0000;
const CPUID_OFFSET: usize = 0xed00;

let cpuid_reg = (SYS_CTRL_ADDR+CPUID_OFFSET) as *const u32;
let cpuid_value = unsafe { *cpuid_reg };
// or
let cpuid_value = unsafe { cpuid_reg.read() };
```

⚠ Compilers optimize code and processors use cache!

Offset	Name	Info
0xe010	SYST_CSR	SysTick Control and Status Register
0xe014	SYST_RVR	SysTick Reload Value Register
0xe018	SYST_CVR	SysTick Current Value Register
0xe01c	SYST_CALIB	SysTick Calibration Value Register
0xe100	NVIC_IJSER	Interrupt Set-Enable Register
0xe180	NVIC_ICER	Interrupt Clear-Enable Register
0xe200	NVIC_ISPR	Interrupt Set-Pending Register
0xe280	NVIC_ICPR	Interrupt Clear-Pending Register
0xe400	NVIC_IPR0	Interrupt Priority Register 0
0xe404	NVIC_IPR1	Interrupt Priority Register 1
0xe408	NVIC_IPR2	Interrupt Priority Register 2
0xe40c	NVIC_IPR3	Interrupt Priority Register 3
0xe410	NVIC_IPR4	Interrupt Priority Register 4
0xe414	NVIC_IPR5	Interrupt Priority Register 5
0xe418	NVIC_IPR6	Interrupt Priority Register 6
0xe41c	NVIC_IPR7	Interrupt Priority Register 7
0xed00	CPUID	CPUID Base Register
0xed04	ICSR	Interrupt Control and State Register
0xed08	VTOR	Vector Table Offset Register
0xed0c	AIRCR	Application Interrupt and Reset Control Register
0xed10	SCR	System Control Register
0xed14	CCR	Configuration and Control Register

1. Cortex-M33 has some additional registers ↔



Compiler Optimization

compilers optimize code

Write bytes to the `UART` (serial port) data register

```
1 // we use mut as we need to write to it
2 const UART_TX: *mut u8 = 0x4003_4000 as *mut u8;
3 // b".." means ASCII string slice (Rust uses UTF-8 strings by default)
4 for character in b"Hello, World".iter() {
5     // character is &char, so we use *character to get the value
6     unsafe { UART_TX.write(*character); }
7 }
```

1. The compiler does not know that `UART_TX` is a register and uses it as a memory address.
2. Writing several values to the same memory address will result in having the last value stored at that address.
3. The compiler optimizes the code write the value

```
1 const UART_TX: *mut u8 = 0x4003_4000;
2 unsafe { UART_TX.write(b'd'); }
```



No Compiler Optimization

CPUID: `0xe000_ed00` (`0xe000_0000 + 0xed00`)

```
use core::ptr::read_volatile;

const SYS_CTRL_ADDR: usize = 0xe000_0000;
const CPUID_OFST: usize = 0xed00;

let cpuid_reg = (SYS_CTRL_ADDR + CPUID_OFST) as *const u32;
unsafe {
    // avoid compiler optimization
    read_volatile(cpuid_reg)
}
```

`read_volatile`,
`write_volatile`

**no compiler
optimization**

`read`, `write`, `*p`

**use compiler
optimization**

Offset	Name	Info
0xe010	SYST_CSR	SysTick Control and Status Register
0xe014	SYST_RVR	SysTick Reload Value Register
0xe018	SYST_CVR	SysTick Current Value Register
0xe01c	SYST_CALIB	SysTick Calibration Value Register
0xe100	NVIC_IJSER	Interrupt Set-Enable Register
0xe180	NVIC_ICER	Interrupt Clear-Enable Register
0xe200	NVIC_ISPR	Interrupt Set-Pending Register
0xe280	NVIC_ICPR	Interrupt Clear-Pending Register
0xe400	NVIC_IPR0	Interrupt Priority Register 0
0xe404	NVIC_IPR1	Interrupt Priority Register 1
0xe408	NVIC_IPR2	Interrupt Priority Register 2
0xe40c	NVIC_IPR3	Interrupt Priority Register 3
0xe410	NVIC_IPR4	Interrupt Priority Register 4
0xe414	NVIC_IPR5	Interrupt Priority Register 5
0xe418	NVIC_IPR6	Interrupt Priority Register 6
0xe41c	NVIC_IPR7	Interrupt Priority Register 7
0xed00	CPUID	CPUID Base Register
0xed04	ICSR	Interrupt Control and State Register
0xed08	VTOR	Vector Table Offset Register
0xed0c	AIRCR	Application Interrupt and Reset Control Register
0xed10	SCR	System Control Register
0xed14	CCR	Configuration and Control Register

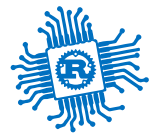

No Compiler Optimization

Write bytes to the `UART` (serial port) data register

```
1 use core::ptr::write_volatile;
2
3 // we use mut as we need to write to it
4 const UART_TX: *mut u8 = 0x4003_4000 as *mut u8;
5 // b".." means ASCII string slice (Rust uses UTF-8 strings by default)
6 for character in b"Hello, World".iter() {
7     // character is &char, so we use *character to get the value
8     unsafe { write_volatile(UART_TX, *character); }
9 }
```

The compiler **knows** that `UART_TX` **must be written** every time.

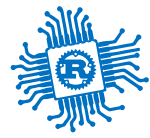

8 bit processor

with cache

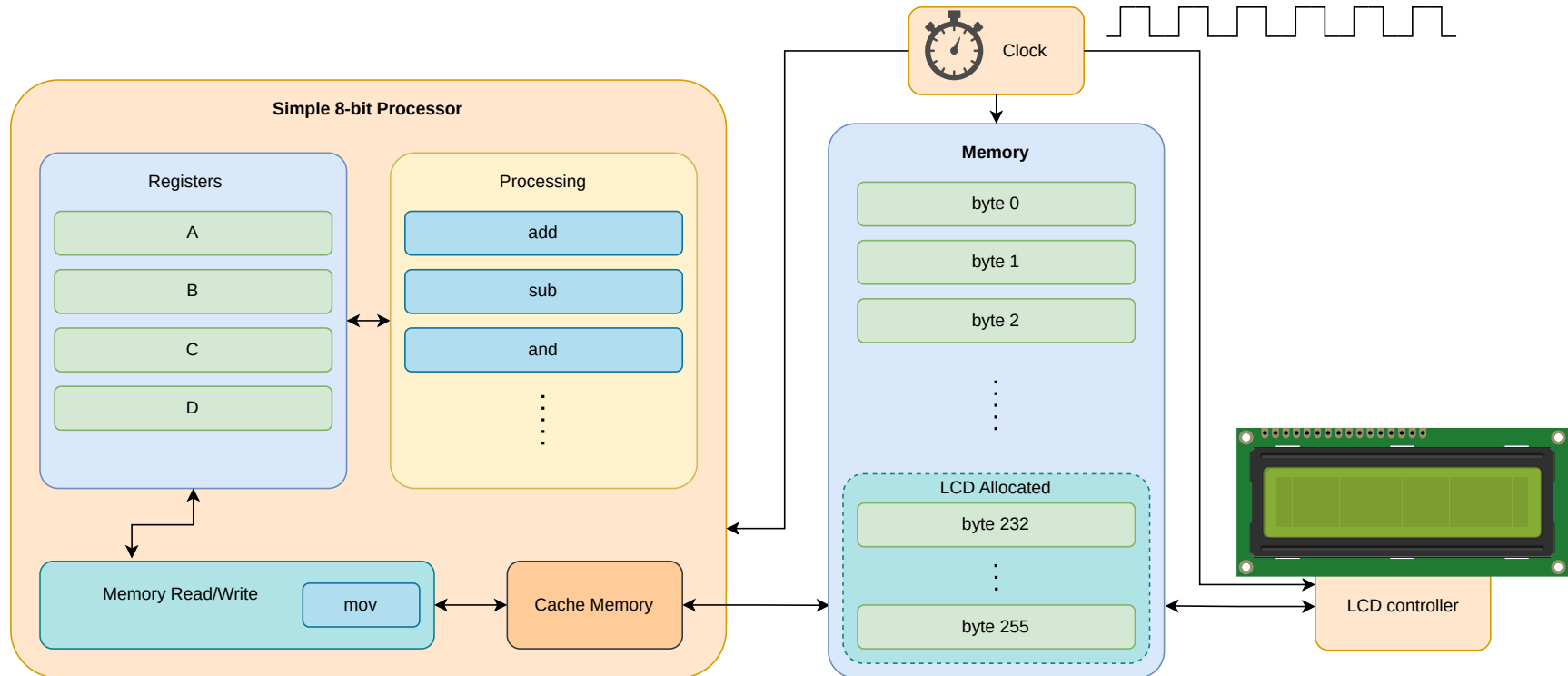



No Cache or Flush Cache

- Cache types:
 - *write-through* - data is written to the cache and to the main memory (bus)
 - *write-back* - data is written to the cache and later to the main memory (bus)
- few Cortex-M MCUs have cache
- the Memory Mapped I/O region is set as *nocache*
- for chips that use cache
 - *nocache* regions have to be set manually (if MCU knows)
 - or, the cache has to be flushed before a `volatile_read` and after a `volatile_write`
 - beware DMA controllers that can't see the cache contents



Read the CPUID

About the MCU

```
use core::ptr::read_volatile;

const SYS_CTRL_ADDR: usize = 0xe000_0000;
const CPUID_OFST: usize = 0xed00;

let cpuid_reg = (SYS_CTRL_ADDR+CPUID_OFST) as *const u32;
let cpuid_value = unsafe {
    read_volatile(cpuid_reg)
};

// shift right 20 bits and keep only the last 4 bits
let variant = (cpuid_value >> 20) & 0b1111;

// shift right 16 bits and keep only the last 4 bits
let architecture = (cpuid_value >> 16) & 0b1111;

// shift right 4 bits and keep only the last 12 bits
let part_no = (cpuid_value >> 4) & 0b1111_1111_1111;

// shift right 0 bits and keep only the last 4 bits
let revision = (cpuid_value >> 0) & 0b1111;
```

CPUID Register

Offset: 0xed00

Bits	Name	Description	Type	Reset
31:24	IMPLEMENTER	Implementor code: 0x41 = ARM	RO	0x41
23:20	VARIANT	Major revision number n in the rmpm revision status: 0x0 = Revision 0.	RO	0x0
19:16	ARCHITECTURE	Constant that defines the architecture of the processor: 0xC = ARMv6-M architecture.	RO	0xc
15:4	PARTNO	Number of processor within family: 0xC60 = Cortex-M0+	RO	0xc60
3:0	REVISION	Minor revision number m in the rmpm revision status: 0x1 = Patch 1.	RO	0x1



AIRCR

Application Interrupt and Reset Control Register

```
use core::ptr::read_volatile;
use core::ptr::write_volatile;

const SYS_CTRL_ADDR: usize = 0xe000_0000;
const AIRCR_OFST: usize = 0xed0c;

const VECTKEY_POS: u32 = 16;
const SYSRESETREQ_POS: u32 = 2;

let aircr_register = (SYS_CTRL + AIRCR) as *mut u32;
let mut aircr_value = unsafe {
    read_volatile(aircr_register)
};

aircr_value = aircr_value & !(0xffff << VECTKEY_POS);
aircr_value = aircr_value | (0x05fa << VECTKEY_POS);
aircr_value = aircr_value | (1 << SYSRESETREQ_POS);

unsafe {
    write_volatile(aircr_register, aircr_value);
}
```

AIRCR Register

Offset: 0xed0c

Bits	Name	Description	Type	Reset
31:16	VECTKEY	Register key: Reads as Unknown On writes, write 0x05FA to VECTKEY, otherwise the write is ignored.	RW	0x0000
15	ENDIANESS	Data endianness implemented: 0 = Little-endian.	RO	0x0
14:3	Reserved.	-	-	-

Bits	Name	Description	Type	Reset
2	SYSRESETREQ	Writing 1 to this bit causes the SYSRESETREQ signal to the outer system to be asserted to request a reset. The intention is to force a large system reset of all major components except for debug. The C_HALT bit in the DHCSR is cleared as a result of the system reset requested. The debugger does not lose contact with the device.	RW	0x0
1	VECTCLRACTIVE	Clears all active state information for fixed and configurable exceptions. This bit is self-clearing, can only be set by the DAP when the core is halted. When set: clears all active exception status of the processor, forces a return to Thread mode, forces an IPSR of 0. A debugger must re-initialize the stack.	RW	0x0
0	Reserved.	-	-	-



Read and Write

they do stuff

- Read
 - reads the value of a register
 - might ask the peripheral to do something
- Write
 - writes the value to a register
 - might ask the peripheral to do something
 - `SYSRESETREQ`

AIRCR Register

Offset: 0xed0c

Bits	Name	Description	Type	Reset
31:16	VECTKEY	Register key: Reads as Unknown On writes, write 0x05FA to VECTKEY, otherwise the write is ignored.	RW	0x0000
15	ENDIANESS	Data endianness implemented: 0 = Little-endian.	RO	0x0
14:3	Reserved.	-	-	-

Bits	Name	Description	Type	Reset
2	SYSRESETREQ	Writing 1 to this bit causes the SYSRESETREQ signal to the outer system to be asserted to request a reset. The intention is to force a large system reset of all major components except for debug. The C_HALT bit in the DHCSR is cleared as a result of the system reset requested. The debugger does not lose contact with the device.	RW	0x0
1	VECTCLRACTIVE	Clears all active state information for fixed and configurable exceptions. This bit is self-clearing, can only be set by the DAP when the core is halted. When set: clears all active exception status of the processor, forces a return to Thread mode, forces an IPSR of 0. A debugger must re-initialize the stack.	RW	0x0
0	Reserved.	-	-	-

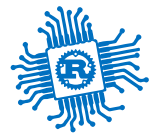

SVD XML File

System View Description

```
1  <device schemaVersion="1.1"
2    xmlns:xs="http://www.w3.org/2001/XMLSchema-instance" xs:noNamespaceSchemaLocation="CMSIS-SVD.xsd">
3    <name>RP2040</name>
4    <peripherals>
5      <name>PPB</name>
6      <baseAddress>0xe0000000</baseAddress>
7      <register>
8        <name>CPUID</name>
9        <addressOffset>0xed00</addressOffset>
10       <resetValue>0x410cc601</resetValue>
11       <fields>
12         <field>
13           <name>IMPLEMENTER</name>
14           <description>Implementor code: 0x41 = ARM</description>
15           <bitRange>[31:24]</bitRange>
16           <access>read-only</access>
17         </field>
18         <!-- rest of the fields of the register -->
19       </fields>
20     </register>
21   </peripherals>
22 </device>
```



tock-registers

define registers format

```
1 use tock_registers::register_bitfields;
2 register_bitfields! {u32,
3     CPUID [
4         IMPLEMENTER OFFSET(24) NUMBITS(8) [],
5         VARIANT OFFSET(20) NUMBITS(4) [],
6         ARCHITECTURE OFFSET(16) NUMBITS(4) [
7             ARM_V6_M = 0xc,
8             ARM_V8_M = 0xa
9         ],
10        PARTNO OFFSET(4) NUMBITS(12) [
11            CORTEX_M0P = 0xc60,
12            CORTEX_M33 = 0xd21
13        ],
14        REVISION OFFSET(0) NUMBITS(2) []
15    ],
16    AIRCR [
17        VECTKEY OFFSET(16) NUMBITS(8) [KEY = 0x05fa],
18        ENDIANNESS OFFSET(15) NUMBITS(1) [],
19        SYSRESETREQ OFFSET(2) NUMBITS(1) [],
20        VECTCLRACTIVE OFFSET(1) NUMBITS(1) []
21    ]
22 }
```

Bits	Name	Description	Type	Reset
31:24	IMPLEMENTER	Implementor code: 0x41 = ARM	RO	0x41
23:20	VARIANT	Major revision number n in the rmpm revision status: 0x0 = Revision 0.	RO	0x0
19:16	ARCHITECTURE	Constant that defines the architecture of the processor: 0xC = ARMv6-M architecture.	RO	0xc
15:4	PARTNO	Number of processor within family: 0xC60 = Cortex-M0+	RO	0xc60
3:0	REVISION	Minor revision number m in the rmpm revision status: 0x1 = Patch 1.	RO	0x1

Bits	Name	Description	Type	Reset
31:16	VECTKEY	Register key: Reads as Unknown On writes, write 0x05FA to VECTKEY, otherwise the write is ignored.	RW	0x0000
15	ENDIANNESS	Data endianness implemented: 0 = Little-endian.	RO	0x0
14:3	Reserved.	-	-	-



tock-registers

define a structure for the peripheral

```
use tock_registers::register_structs;
use tock_registers::registers::{ReadOnly, ReadWrite};

// generates a C-style SysCtrl struct
register_structs! {
SysCtrl {
    // we registers up to 0xed00
    (0x0000 => _reserved1),
    // we define the CPUID register
    (0xed00 => cpuid: ReadOnly<u32, CPUID::Register>),
    // we registers up to 0xed
    (0xed04 => _reserved2),
    // we define the AIRCR register
    (0xed0c => aircr: ReadWrite<u32, AIRCR::Register>),
    // we ignore the rest of the registers
    (0xed10 => @END),
}
}
```

Offset	Name	Info
0xe010	SYST_CSR	SysTick Control and Status Register
0xe014	SYST_RVR	SysTick Reload Value Register
0xe018	SYST_CVR	SysTick Current Value Register
0xe01c	SYST_CALIB	SysTick Calibration Value Register
0xe100	NVIC_IJSER	Interrupt Set-Enable Register
0xe180	NVIC_ICER	Interrupt Clear-Enable Register
0xe200	NVIC_ISPR	Interrupt Set-Pending Register
0xe280	NVIC_ICPR	Interrupt Clear-Pending Register
0xe400	NVIC_IPR0	Interrupt Priority Register 0
0xe404	NVIC_IPR1	Interrupt Priority Register 1
0xe408	NVIC_IPR2	Interrupt Priority Register 2
0xe40c	NVIC_IPR3	Interrupt Priority Register 3
0xe410	NVIC_IPR4	Interrupt Priority Register 4
0xe414	NVIC_IPR5	Interrupt Priority Register 5
0xe418	NVIC_IPR6	Interrupt Priority Register 6
0xe41c	NVIC_IPR7	Interrupt Priority Register 7
0xed00	CPUID	CPUID Base Register
0xed04	ICSR	Interrupt Control and State Register
0xed08	VTOR	Vector Table Offset Register
0xed0c	AIRCR	Application Interrupt and Reset Control Register
0xed10	SCR	System Control Register
0xed14	CCR	Configuration and Control Register



Reset the processor

using tock-registers

```
1  const SYS_CTRL_ADDR: usize = 0xe000_0000;
2
3  register_bitfields! {u32,
4      // ...
5      AIRCR [
6          VECTKEY OFFSET(16) NUMBITS(8) [KEY = 0x05fa],
7          ENDIANESS OFFSET(15) NUMBITS(1) [],
8          SYSRESETRREQ OFFSET(2) NUMBITS(1) [],
9          VECTCLRACTIVE OFFSET(1) NUMBITS(1) []
10     ]
11 }
12
13 register_structs! {
14     SysCtrl {
15         (0xed0c => aircr: ReadWrite<u32, AIRCR::Register>),
16     }
17 }
18
19 let sys_ctrl = unsafe { &*(SYS_CTRL_ADDR as *const SysCtrl) }; // C: struct SysCtrl *sys_ctrl = SYS_CTRL_ADDR;
20
21 sys_ctrl.aircr
22     .modify(AIRCR::VECTKEY::KEY + AIRCR::SYSRESETRREQ::SET);
```

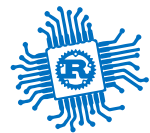

Read the CPUID

using `tock-registers`

```
1  const SYS_CTRL_ADDR: usize = 0xe000_0000;
2  register_bitfields! {u32,
3      CPUID [
4          IMPLEMENTER OFFSET(24) NUMBITS(8) [],
5          VARIANT OFFSET(20) NUMBITS(4) [],
6          ARCHITECTURE OFFSET(16) NUMBITS(4) [ARMv6M = 0xc, ARMv8M0 = 0xa],
7          PARTNO OFFSET(4) NUMBITS(12) [CORTEX_M0P = 0xc60, CORTEX_M33 = 0xd21],
8          REVISION OFFSET(0) NUMBITS(2) []
9      ],
10     // ...
11 }
12 let sys_ctrl = unsafe { &*(SYS_CTRL_ADDR as *const SysCtrl) };
13
14 let variant = sys_ctrl.cpuid.read(CPUID::VARIANT);
15 let revision = sys_ctrl.cpuid.read(CPUID::REVISION);
16 let architecture = sys_ctrl.cpuid.read(CPUID::ARCHITECTURE);
17 let part_no = sys_ctrl.cpuid.read(CPUID::PARTNO);
18
19 if part_no == CPUID::PARTNO::Value::CORTEX_M0P as u32 {
20     // this is a Cortex-M0+
21 } else if part_no == CPUID::PARTNO::Value::CORTEX_M33 as u32 {
```

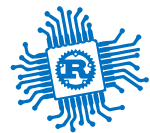

GPIO

General Purpose Input Output for RP2040

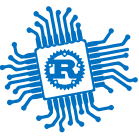

Bibliography

for this section

Raspberry Pi Ltd, *RP2040 Datasheet*

- Chapter 2 - *System Description*
 - Section 2.3 - *Processor subsystem*
 - Subsection 2.3.1 - *SIO*
 - Subsection 2.3.1.2 - *GPIO Control*
 - Section 2.4 - *Cortex-M0+* (except NVIC and MPU)
 - Section 2.19 - *GPIO* (except Interrupts)



RP2040 GPIO Pins

GPIO pins are connected to the processor pins through three peripherals

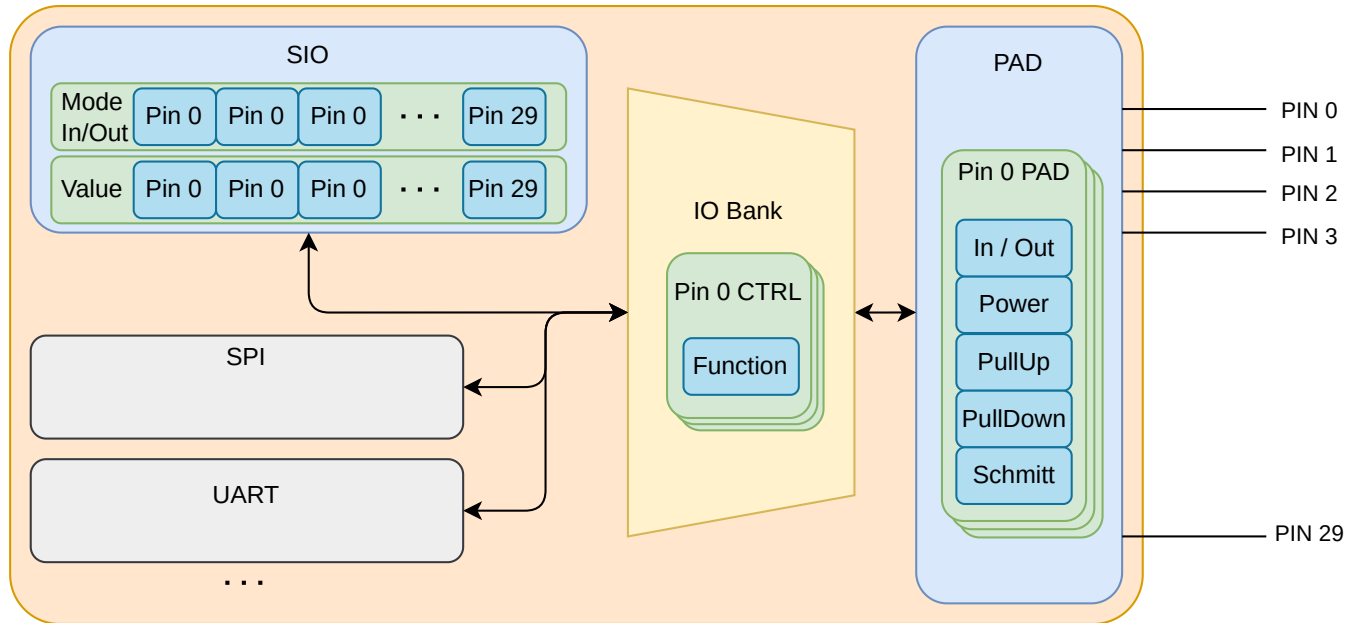

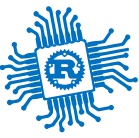

GPIO

Peripherals

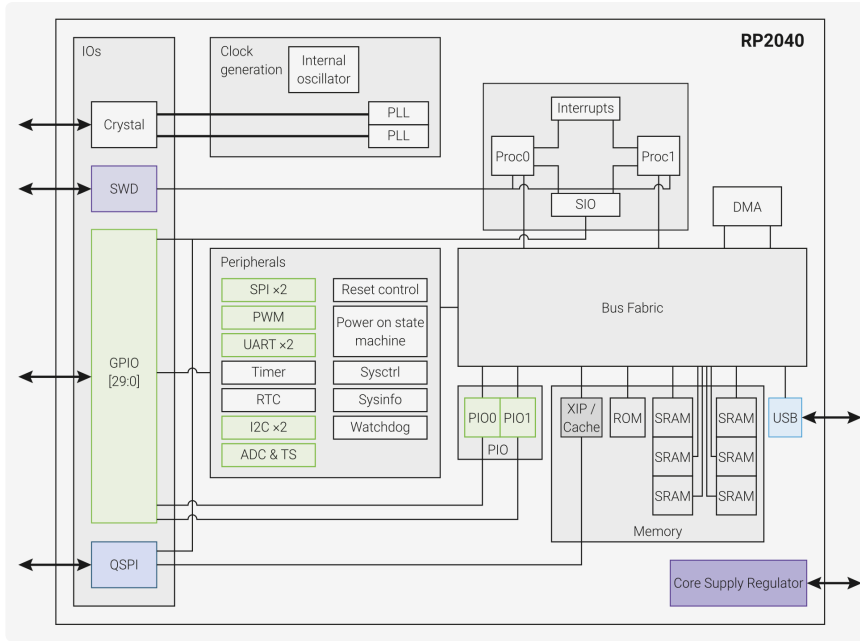

SIO Single Cycle Input/Output, is able to control the GPIO pins

GPIO Multiplexes the functions of the GPIO pins



SIO: Set the pin as Input or Output

IO Bank (GPIO): Use the correct MUX function (F5)

PAD: Set the pin input and output parameters

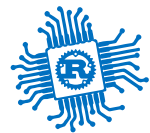

SIO Registers

The SIO registers start at a base address of `0xd0000000` (defined as `SIO_BASE` in SDK).

Offset	Name	Info
0x000	CPUID	Processor core identifier
0x004	GPIO_IN	Input value for GPIO pins
0x008	GPIO_HI_IN	Input value for QSPI pins
0x010	GPIO_OUT	GPIO output value
0x014	GPIO_OUT_SET	GPIO output value set
0x018	GPIO_OUT_CLR	GPIO output value clear
0x01c	GPIO_OUT_XOR	GPIO output value XOR
0x020	GPIO_OE	GPIO output enable
0x024	GPIO_OE_SET	GPIO output enable set
0x028	GPIO_OE_CLR	GPIO output enable clear

- Input
 - set `GPIO_OE` bit `x` to 0
 - read `GPIO_IN` bit `x`
- Output
 - set `GPIO_OE` bit `x` to 1
 - write `GPIO_OUT` bit `x`

GPIO_OE

Bits	Description	Type	Reset
31:30	Reserved.	-	-
29:0	Set output enable (1/0 → output/input) for GPIO0...29. Reading back gives the last value written. If core 0 and core 1 both write to <code>GPIO_OE</code> simultaneously (or to a <code>SET/CLR/XOR</code> alias), the result is as though the write from core 0 took place first, and the write from core 1 was then applied to that intermediate result.	RW	0x00000000

GPIO_IN

Bits	Description	Type	Reset
31:30	Reserved.	-	-
29:0	Input value for GPIO0...29	RO	0x00000000

GPIO_OUT

Bits	Description	Type	Reset
31:30	Reserved.	-	-
29:0	Set output level (1/0 → high/low) for GPIO0...29. Reading back gives the last value written, NOT the input value from the pins. If core 0 and core 1 both write to <code>GPIO_OUT</code> simultaneously (or to a <code>SET/CLR/XOR</code> alias), the result is as though the write from core 0 took place first, and the write from core 1 was then applied to that intermediate result.	RW	0x00000000

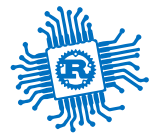

SIO Input

The SIO registers start at a base address of `0xd0000000` (defined as `SIO_BASE` in SDK).

Offset	Name	Info
0x000	CPUID	Processor core identifier
0x004	GPIO_IN	Input value for GPIO pins
0x008	GPIO_HI_IN	Input value for QSPI pins
0x010	GPIO_OUT	GPIO output value
0x014	GPIO_OUT_SET	GPIO output value set
0x018	GPIO_OUT_CLR	GPIO output value clear
0x01c	GPIO_OUT_XOR	GPIO output value XOR
0x020	GPIO_OE	GPIO output enable
0x024	GPIO_OE_SET	GPIO output enable set
0x028	GPIO_OE_CLR	GPIO output enable clear

GPIO_OE

Bits	Description	Type	Reset
31:30	Reserved.	-	-
29:0	Set output enable (1/0 → output/input) for GPIO0...29. Reading back gives the last value written. If core 0 and core 1 both write to GPIO_OE simultaneously (or to a SET/CLR/XOR alias), the result is as though the write from core 0 took place first, and the write from core 1 was then applied to that intermediate result.	RW	0x00000000

GPIO_IN

Bits	Description	Type	Reset
31:30	Reserved.	-	-
29:0	Input value for GPIO0...29	RO	0x00000000

```
1 use core::ptr::read_volatile;
2 use core::ptr::write_volatile;
3
4 const GPIO_OE: *mut u32 = 0xd000_0020 as *mut u32;
5 const GPIO_IN: *const u32 = 0xd000_0004 as *const u32;
6
7 let value = unsafe {
8     // write_volatile(GPIO_OE, !(1 << pin));
9     let mut gpio_oe = read_volatile(GPIO_OE);
10    // set bin `pin` of `gpio_oe` to 0 (input)
11    gpio_oe = gpio_oe & !(1 << pin);
12    write_volatile(GPIO_OE, gpio_oe);
13    read_volatile(GPIO_IN) >> pin & 0b1
14 };
```



SIO Input

The SIO registers start at a base address of `0xd0000000` (defined as `SIO_BASE` in SDK).

Offset	Name	Info
0x000	CPUID	Processor core identifier
0x004	GPIO_IN	Input value for GPIO pins
0x008	GPIO_HI_IN	Input value for QSPI pins
0x010	GPIO_OUT	GPIO output value
0x014	GPIO_OUT_SET	GPIO output value set
0x018	GPIO_OUT_CLR	GPIO output value clear
0x01c	GPIO_OUT_XOR	GPIO output value XOR
0x020	GPIO_OE	GPIO output enable
0x024	GPIO_OE_SET	GPIO output enable set
0x028	GPIO_OE_CLR	GPIO output enable clear

GPIO_OE_SET

Bits	Description	Type	Reset
31:30	Reserved.	-	-
29:0	Perform an atomic bit-clear on GPIO_OE, i.e. <code>GPIO_OE &= ~wdata</code>	WO	0x00000000

GPIO_IN

Bits	Description	Type	Reset
31:30	Reserved.	-	-
29:0	Input value for GPIO0...29	RO	0x00000000

```
1 use core::ptr::read_volatile;
2 use core::ptr::write_volatile;
3
4 const GPIO_OE_CLR: *mut u32= 0xd000_0028 as *mut u32;
5 const GPIO_IN: *const u32= 0xd000_0004 as *const u32;
6
7 let value = unsafe {
8     // set bit `pin` of `GPIO_OE` to 0 (input)
9     write_volatile(GPIO_OE_CLR, 1 << pin);
10    read_volatile(GPIO_IN) >> pin & 0b1
11 };
```



SIO Output

The SIO registers start at a base address of `0xd0000000` (defined as `SIO_BASE` in SDK).

Offset	Name	Info
0x000	CPUID	Processor core identifier
0x004	GPIO_IN	Input value for GPIO pins
0x008	GPIO_HI_IN	Input value for QSPI pins
0x010	GPIO_OUT	GPIO output value
0x014	GPIO_OUT_SET	GPIO output value set
0x018	GPIO_OUT_CLR	GPIO output value clear
0x01c	GPIO_OUT_XOR	GPIO output value XOR
0x020	GPIO_OE	GPIO output enable
0x024	GPIO_OE_SET	GPIO output enable set
0x028	GPIO_OE_CLR	GPIO output enable clear

GPIO_OE_CLR

Bits	Description	Type	Reset
31:30	Reserved.	-	-
29:0	Perform an atomic bit-clear on GPIO_OE, i.e. <code>GPIO_OE &= ~wdata</code>	WO	0x00000000

GPIO_OUT

Bits	Description	Type	Reset
31:30	Reserved.	-	-
29:0	Set output level (1/0 → high/low) for GPIO0..29. Reading back gives the last value written, NOT the input value from the pins. If core 0 and core 1 both write to GPIO_OUT simultaneously (or to a SET/CLR/XOR alias), the result is as though the write from core 0 took place first, and the write from core 1 was then applied to that intermediate result.	RW	0x00000000

```
1 use core::ptr::read_volatile;
2 use core::ptr::write_volatile;
3
4 const GPIO_OE_SET: *mut u32 = 0xd000_0024 as *mut u32;
5 const GPIO_OUT: *mut u32 = 0xd000_0010 as *mut u32;
6
7 unsafe {
8     // set bit `pin` of GPIO_OE to 1 (output)
9     write_volatile(GPIO_OE_SET, 1 << pin);
10    // write_volatile(GPIO_OUT, (value & 0b1) << pin);
11    let mut gpio_out = read_volatile(GPIO_OUT);
12    gpio_out = gpio_out | (value & 0b1) << pin;
13    write_volatile(GPIO_OUT, gpio_out);
14 }
```



SIO Output

efficient

The SIO registers start at a base address of `0xd0000000` (defined as `SIO_BASE` in SDK).

Offset	Name	Info
0x000	CPUID	Processor core identifier
0x004	GPIO_IN	Input value for GPIO pins
0x008	GPIO_HI_IN	Input value for QSPI pins
0x010	GPIO_OUT	GPIO output value
0x014	GPIO_OUT_SET	GPIO output value set
0x018	GPIO_OUT_CLR	GPIO output value clear
0x01c	GPIO_OUT_XOR	GPIO output value XOR
0x020	GPIO_OE	GPIO output enable
0x024	GPIO_OE_SET	GPIO output enable set
0x028	GPIO_OE_CLR	GPIO output enable clear

GPIO_OUT_SET

Bits	Description	Type	Reset
31:30	Reserved.	-	-
29:0	Perform an atomic bit-set on GPIO_OUT, i.e. <code>GPIO_OUT = wdata</code>	WO	0x00000000

GPIO_OUT_CLR

Bits	Description	Type	Reset
31:30	Reserved.	-	-
29:0	Perform an atomic bit-clear on GPIO_OUT, i.e. <code>GPIO_OUT &= ~wdata</code>	WO	0x00000000

```
1 use core::ptr::read_volatile;
2 use core::ptr::write_volatile;
3
4 const GPIO_OE_SET: *mut u32= 0xd000_0024 as *mut u32;
5 const GPIO_OUT_SET:*mut u32= 0xd000_0014 as *mut u32;
6 const GPIO_OUT_CLR:*mut u32= 0xd000_0018 as *mut u32;
7
8 unsafe {
9     write_volatile(GPIO_OE_SET, 1 << pin);
10    let reg = match value {
11        0 => GPIO_OUT_CLR,
12        _ => GPIO_OUT_SET
13    };
14    write_volatile(reg, 1 << pin);
15 }
```



IO Bank

GPIOx_CTRL

Offset: 0x004, 0x00c, ... 0x0ec ($0x4 + 8 * x$)

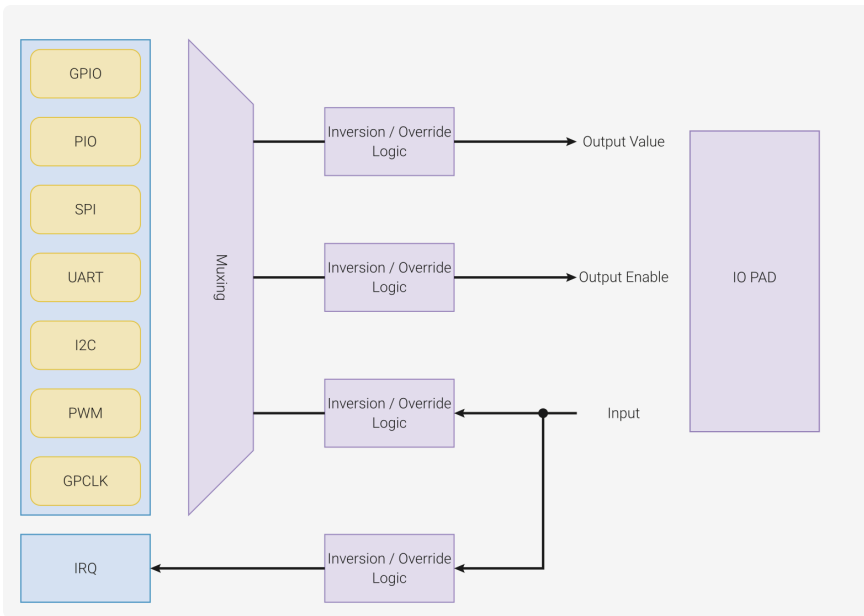

The User Bank IO registers start at a base address of `0x40014000` (defined as `IO_BANK0_BASE` in SDK).

Offset	Name	Info
0x000	<code>GPIO0_STATUS</code>	GPIO status
0x004	<code>GPIO0_CTRL</code>	GPIO control including function select and overrides.

Bits	Name	Description	Type	Reset
31:30	Reserved.	-	-	-
29:28	IRQOVER	0x0 → don't invert the interrupt 0x1 → invert the interrupt 0x2 → drive interrupt low 0x3 → drive interrupt high	RW	0x0
27:18	Reserved.	-	-	-
17:16	INOVER	0x0 → don't invert the peri input 0x1 → invert the peri input 0x2 → drive peri input low 0x3 → drive peri input high	RW	0x0
15:14	Reserved.	-	-	-
13:12	OEOVER	0x0 → drive output enable from peripheral signal selected by funcsel 0x1 → drive output enable from inverse of peripheral signal selected by funcsel 0x2 → disable output 0x3 → enable output	RW	0x0
11:10	Reserved.	-	-	-
9:8	OUTOVER	0x0 → drive output from peripheral signal selected by funcsel 0x1 → drive output from inverse of peripheral signal selected by funcsel 0x2 → drive output low 0x3 → drive output high	RW	0x0
7:5	Reserved.	-	-	-
4:0	FUNCSEL	Function select. 31 == NULL. See GPIO function table for available functions.	RW	0x1f

- set `FUNCSEL` to 5 (`SIO`)

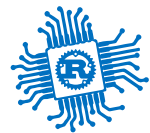

IO Bank Input

The User Bank IO registers start at a base address of `0x40014000` (defined as `IO_BANK0_BASE` in SDK).

Offset	Name	Info
0x000	GPIO0_STATUS	GPIO status
0x004	GPIO0_CTRL	GPIO control including function select and overrides.

```
1 use core::ptr::read_volatile;
2 use core::ptr::write_volatile;
3
4 const GPIOX_CTRL: usize = 0x4001_4004;
5 const GPIO_OE_CLR: *mut u32 = 0xd000_0028 as *mut u32;
6 const GPIO_IN: *const u32 = 0xd000_0004 as *const u32;
7
8 let gpio_ctrl = (GPIOX_CTRL + 8 * pin) as *mut u32;
9
10 let value = unsafe {
11     write_volatile(gpio_ctrl, 5);
12     write_volatile(GPIO_OE_CLR, 1 << pin);
13     read_volatile(GPIO_IN) >> pin & 0b1
14 };
```

GPIOx_CTRL

Offset: `0x004`, `0x00c`, ... `0x0ec` ($0x4 + 8 * x$)

Bits	Name	Description	Type	Reset
31:30	Reserved.	-	-	-
29:28	IRQOVER	0x0 → don't invert the interrupt 0x1 → invert the interrupt 0x2 → drive interrupt low 0x3 → drive interrupt high	RW	0x0
27:18	Reserved.	-	-	-
17:16	INOVER	0x0 → don't invert the peri input 0x1 → invert the peri input 0x2 → drive peri input low 0x3 → drive peri input high	RW	0x0
15:14	Reserved.	-	-	-
13:12	OEOVER	0x0 → drive output enable from peripheral signal selected by funcsel 0x1 → drive output enable from inverse of peripheral signal selected by funcsel 0x2 → disable output 0x3 → enable output	RW	0x0
11:10	Reserved.	-	-	-
9:8	OUTOVER	0x0 → drive output from peripheral signal selected by funcsel 0x1 → drive output from inverse of peripheral signal selected by funcsel 0x2 → drive output low 0x3 → drive output high	RW	0x0
7:5	Reserved.	-	-	-
4:0	FUNCSEL	Function select. 31 == NULL. See GPIO function table for available functions.	RW	0x1f

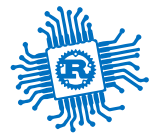

IO Bank Output

The User Bank IO registers start at a base address of `0x40014000` (defined as `IO_BANK0_BASE` in SDK).

Offset	Name	Info
0x000	GPIO0_STATUS	GPIO status
0x004	GPIO0_CTRL	GPIO control including function select and overrides.

```
1 use core::ptr::read_volatile;
2 use core::ptr::write_volatile;
3
4 const GPIOX_CTRL: u32 = 0x4001_4004;
5 const GPIO_OE_SET: *mut u32 = 0xd000_0024 as *mut u32;
6 const GPIO_OUT_SET: *mut u32 = 0xd000_0014 as *mut u32;
7 const GPIO_OUT_CLR: *mut u32 = 0xd000_0018 as *mut u32;
8
9 let gpio_ctrl = (GPIOX_CTRL + 8 * pin) as *mut u32;
10 unsafe {
11     write_volatile(gpio_ctrl, 5);
12     write_volatile(GPIO_OE_SET, 1 << pin);
13     let reg = match value {
14         0 => GPIO_OUT_CLR,
15         _ => GPIO_OUT_SET
16     };
17     write_volatile(reg, 1 << pin);
18 };
```

GPIOx_CTRL

Offset: `0x004, 0x00c, ... 0x0ec` ($0x4 + 8 * x$)

Bits	Name	Description	Type	Reset
31:30	Reserved.	-	-	-
29:28	IRQOVER	0x0 → don't invert the interrupt 0x1 → invert the interrupt 0x2 → drive interrupt low 0x3 → drive interrupt high	RW	0x0
27:18	Reserved.	-	-	-
17:16	INOVER	0x0 → don't invert the peri input 0x1 → invert the peri input 0x2 → drive peri input low 0x3 → drive peri input high	RW	0x0
15:14	Reserved.	-	-	-
13:12	OEOVER	0x0 → drive output enable from peripheral signal selected by funcsel 0x1 → drive output enable from inverse of peripheral signal selected by funcsel 0x2 → disable output 0x3 → enable output	RW	0x0
11:10	Reserved.	-	-	-
9:8	OUTOVER	0x0 → drive output from peripheral signal selected by funcsel 0x1 → drive output from inverse of peripheral signal selected by funcsel 0x2 → drive output low 0x3 → drive output high	RW	0x0
7:5	Reserved.	-	-	-
4:0	FUNCSEL	Function select. 31 == NULL. See GPIO function table for available functions.	RW	0x1f

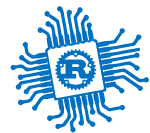

Pad Control

GPIOx Register

Offset: 0x004, 0x008, ... 0x078 (0x4 + 4*x)

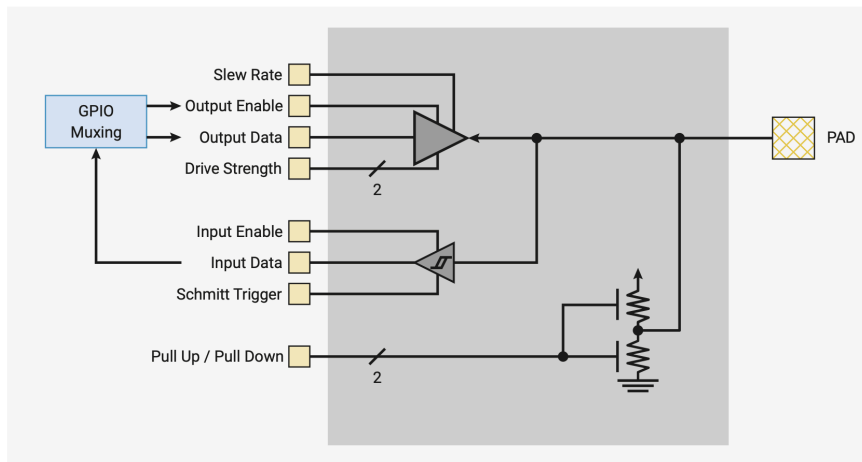

The User Bank Pad Control registers start at a base address of 0x4001c000 (defined as PADS_BANK0_BASE in SDK).

Offset	Name	Info
0x00	VOLTAGE_SELECT	Voltage select. Per bank control
0x04	GPIO0	Pad control register
0x08	GPIO1	Pad control register
0x0c	GPIO2	Pad control register
0x10	GPIO3	Pad control register
0x14	GPIO4	Pad control register
0x18	GPIO5	Pad control register

Bits	Name	Description	Type	Reset
31:8	Reserved.	-	-	-
7	OD	Output disable. Has priority over output enable from peripherals	RW	0x0
6	IE	Input enable	RW	0x1

Bits	Name	Description	Type	Reset
5:4	DRIVE	Drive strength. 0x0 → 2mA 0x1 → 4mA 0x2 → 8mA 0x3 → 12mA	RW	0x1
3	PUE	Pull up enable	RW	0x0
2	PDE	Pull down enable	RW	0x1
1	SCHMITT	Enable schmitt trigger	RW	0x1
0	SLEWFAST	Slew rate control. 1 = Fast, 0 = Slow	RW	0x0



Input

read the value from pin x

- set the `FUNCSEL` field of `GPIOx_CTRL` to `5`
- set the `GPIO_OE_CLR` bit x to `1`
- read the `GPIO_IN` bit x
- *adjust the `GPIOx` fields to set the pull up/down resistor*

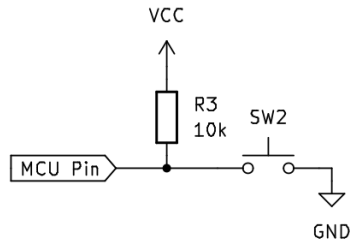

Output

write a value to pin x

- set the `FUNCSEL` field of `GPIOx_CTRL` to `5`
- set the `GPIO_OE_SET` bit x to `1`
- if the value
 - is `0`, set the `GPIO_OUT_CLR` bit x to `1`
 - is `1`, set the `GPIO_OUT_SET` bit x to `1`
- *adjust the `GPIOx` fields to set the output current*

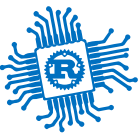

GPIO

General Purpose Input Output for STM32U545

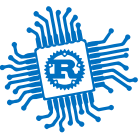

Bibliography

Reference manuals

STMicroelectronics, *STM32U5 Series based on Arm®-based 32-bit MCUs*

- Chapter 2 - *Memory and Bus architecture*
 - Section 2.3 - *Memory organization*
- Chapter 11 - *Reset and Clock Control*
 - Subsection 11.4.24 - *Peripherals clock gating and autonomous mode*
- Chapter 13 - *General-purpose I/Os (GPIO)*

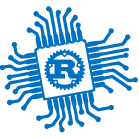

STM32U545 GPIO Pins

GPIO pins are split into smaller groups of up to 16 pins called Ports.

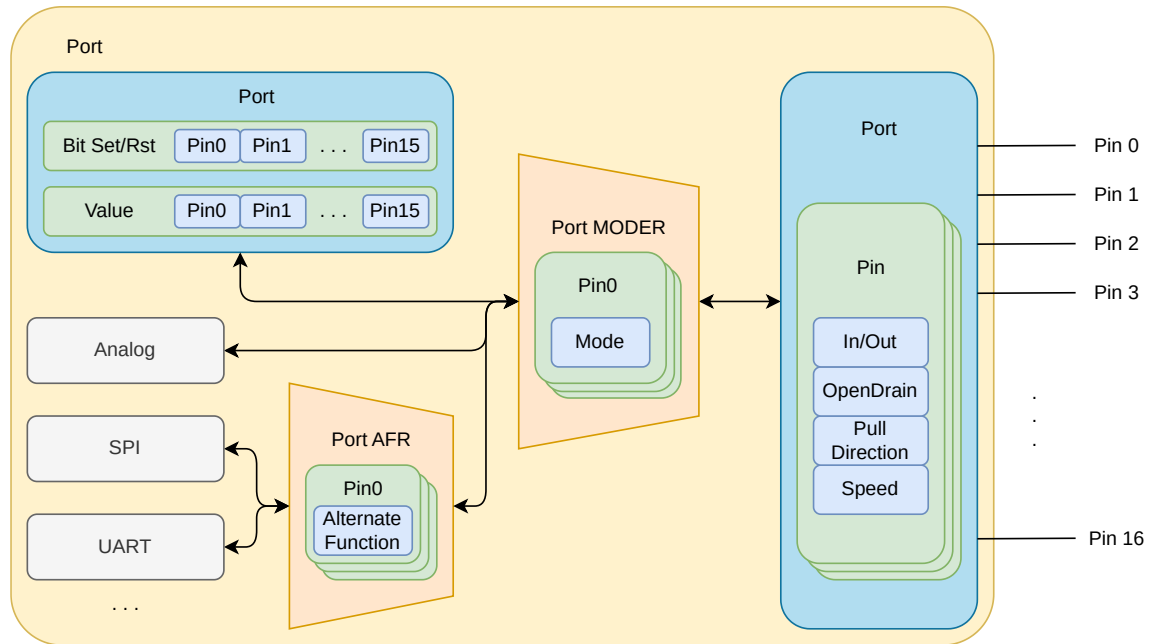



GPIO Registers

RCC AHB2 peripheral clock enable register 1

31	30	29	28	27	26	25	24	23	22	21	20	19	18	17	16
SRAM3 EN	SRAM2 EN	Res.	SDMMC2EN	SDMMC1EN	Res.	Res.	OTFDEC2EN	OTFDEC1EN	Res.	OCTOSPIMEN	SAESEN	PKAEN	RNGEN	HASHEN	AESEN
rw	rw		rw	rw			rw	rw		rw	rw	rw	rw	rw	rw
15	14	13	12	11	10	9	8	7	6	5	4	3	2	1	0
OTGHSPHYEN	OTGEN	Res.	DCMIEN	Res.	ADC12EN	GPIOJEN	GPIOIEN	GPIOHEN	GPIOGEN	GPIOFEN	GPIOEEN	GPIODEN	GPIOCEN	GPIOBEN	GPIOAEN
rw	rw		rw		rw	rw	rw	rw	rw	rw	rw	rw	rw	rw	rw

- Enable I/O Port x clock signal (x from A to J)
 - Set the corresponding GPIOxEN bit
- Input
 - Set GPIOx_MODER bits for pin y to `0b00`
 - Read GPIOx_IDR bit y
- Output
 - Set GPIOx_MODER bits for pin y to `0b01`
 - Set GPIOx_ODR bit y

GPIOx_MODER

31	30	29	28	27	26	25	24	23	22	21	20	19	18	17	16
MODE15[1:0]		MODE14[1:0]		MODE13[1:0]		MODE12[1:0]		MODE11[1:0]		MODE10[1:0]		MODE9[1:0]		MODE8[1:0]	
rw	rw	rw	rw	rw	rw	rw	rw	rw	rw	rw	rw	rw	rw	rw	rw
15	14	13	12	11	10	9	8	7	6	5	4	3	2	1	0
MODE7[1:0]		MODE6[1:0]		MODE5[1:0]		MODE4[1:0]		MODE3[1:0]		MODE2[1:0]		MODE1[1:0]		MODE0[1:0]	
rw	rw	rw	rw	rw	rw	rw	rw	rw	rw	rw	rw	rw	rw	rw	rw

Bits 31:0 **MODEy[1:0]**: Port x configuration I/O pin y (y = 15 to 0)

These bits are written by software to configure the I/O mode.

00: Input mode

01: General purpose output mode

10: Alternate function mode

11: Analog mode (reset state)

GPIOx_ODR

31	30	29	28	27	26	25	24	23	22	21	20	19	18	17	16
Res.	Res.	Res.	Res.	Res.	Res.	Res.	Res.	Res.	Res.	Res.	Res.	Res.	Res.	Res.	Res.
15	14	13	12	11	10	9	8	7	6	5	4	3	2	1	0
OD15	OD14	OD13	OD12	OD11	OD10	OD9	OD8	OD7	OD6	OD5	OD4	OD3	OD2	OD1	OD0
rw	rw	rw	rw	rw	rw	rw	rw	rw	rw	rw	rw	rw	rw	rw	rw

Bits 31:16 Reserved, must be kept at reset value.

Bits 15:0 **ODy**: Port output data I/O pin y (y = 15 to 0)

These bits can be read and written by software.

GPIOx_IDR

31	30	29	28	27	26	25	24	23	22	21	20	19	18	17	16
Res.	Res.	Res.	Res.	Res.	Res.	Res.	Res.	Res.	Res.	Res.	Res.	Res.	Res.	Res.	Res.
15	14	13	12	11	10	9	8	7	6	5	4	3	2	1	0
ID15	ID14	ID13	ID12	ID11	ID10	ID9	ID8	ID7	ID6	ID5	ID4	ID3	ID2	ID1	ID0
r	r	r	r	r	r	r	r	r	r	r	r	r	r	r	r

Bits 31:16 Reserved, must be kept at reset value.

Bits 15:0 **IDy**: Port x input data I/O pin y (y = 15 to 0)

These bits are read-only. They contain the input value of the corresponding I/O port.



GPIO Port enable

RCC AHB2 peripheral clock enable register 1

11.8.30 RCC AHB2 peripheral clock enable register 1 (RCC_AHB2ENR1)

Address offset: 0x08C

Reset value: 0x4000 0000 (for STM32U535/545)

Reset value: 0xC000 0000 (for STM32U575/585/59x/5Ax/5Fx/5Gx)

Access: no wait state, word, half-word, and byte access

Note: When the peripheral clock is not active, read or write access to peripheral registers is not supported.

31	30	29	28	27	26	25	24	23	22	21	20	19	18	17	16
SRAM3 EN	SRAM2 EN	Res.	SDMM C2EN	SDMM C1EN	Res.	Res.	OTFDE C2EN	OTFDE C1EN	Res.	OCTOPIMEN	SAESEN	PKAEN	RNGEN	HASHE N	AESEN
rw	rw		rw	rw			rw	rw		rw	rw	rw	rw	rw	rw
15	14	13	12	11	10	9	8	7	6	5	4	3	2	1	0
OTGH SPHYE N	OTGE N	Res.	DCML PSSIE N	Res.	ADC12 EN	GPIOJ EN	GPIOI EN	GPIOH EN	GPIOG EN	GPIOF EN	GPIOE EN	GPIOD EN	GPIOC EN	GPIOB EN	GPIOA EN
rw	rw		rw		rw	rw	rw	rw	rw	rw	rw	rw	rw	rw	rw

...

Bit 1 GPIOBEN: I/O port B clock enable
 This bit is set and cleared by software.
 0: I/O port B clock disabled
 1: I/O port B clock enabled

Bit 0 GPIOAEN: I/O port A clock enable
 This bit is set and cleared by software.
 0: I/O port A clock disabled
 1: I/O port A clock enabled

Memory map and peripheral register boundary addresses

Bus	Secure boundary address	Nonsecure boundary address	Size (bytes)	Peripheral	Peripheral register map	STM32U535/545	STM32U575/585	STM32U59x/5Ax	STM32U5Fx/5Gx
AHB3	0x5602 6000 - 0x5FFF FFFF	0x4602 6000 - 0x4FFF FFFF	164 M	Reserved	-	-	-	-	-
	0x5602 5000 - 0x5602 5FFF	0x4602 5000 - 0x4602 5FFF	4 K	LPDMA1	LPDMA register map	X	X	X	X
	0x5602 4000 - 0x5602 4FFF	0x4602 4000 - 0x4602 4FFF	4 K	ADF1	ADF register map	X	X	X	X
	0x5602 3C00 - 0x5602 3FFF	0x4602 3C00 - 0x4602 3FFF	1 K	Reserved	-	-	-	-	-
	0x5602 3800 - 0x5602 3BFF	0x4602 3800 - 0x4602 3BFF	1 K	GTZC2 MPCBB4	GTZC2 MPCBB4 register map	X	X	X	X
	0x5602 3400 - 0x5602 37FF	0x4602 3400 - 0x4602 37FF	1 K	GTZC2_TZIC	GTZC2 TZIC register map	X	X	X	X
	0x5602 3000 - 0x5602 33FF	0x4602 3000 - 0x4602 33FF	1 K	GTZC2_TZSC	GTZC2 TZSC register map	X	X	X	X
	0x5602 2400 - 0x5602 2FFF	0x4602 2400 - 0x4602 2FFF	3 K	Reserved	-	-	-	-	-
	0x5602 2000 - 0x5602 23FF	0x4602 2000 - 0x4602 23FF	1 K	EXTI	EXTI register map	X	X	X	X
	0x5602 1C00 - 0x5602 1FFF	0x4602 1C00 - 0x4602 1FFF	1 K	Reserved	-	-	-	-	-
	0x5602 1800 - 0x5602 1BFF	0x4602 1800 - 0x4602 1BFF	1 K	DAC1	DAC register map	X	X	X	X
	0x5602 1400 - 0x5602 17FF	0x4602 1400 - 0x4602 17FF	1 K	Reserved	-	-	-	-	-
	0x5602 1000 - 0x5602 13FF	0x4602 1000 - 0x4602 13FF	1 K	ADC4	ADC register map	X	X	X	X
	0x4602 0C00 - 0x4602 0FFF	0x4602 0C00 - 0x4602 0FFF	1 K	RCC	RCC register map	X	X	X	X

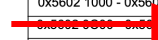

```

1 use core::ptr::write_volatile;
2 use core::ptr::read_volatile;
3
4 const RCC_BASE_ADDR: usize = 0x4602_0C00;
5 const RCC_AHB2ENR1: *mut u32 =
6     (RCC_BASE_ADDR + 0x8C) as *mut u32;
7
8 unsafe {
9     let value = read_volatile(RCC_AHB2ENR1);
10    // enable `port`, where A is 0, B is 1, ...
11    write_volatile(RCC_AHB2ENR1, value | (1 << port));
12 }
  
```

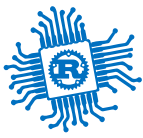

GPIO Output

GPIOx_MODER - address offset: 0x00

31	30	29	28	27	26	25	24	23	22	21	20	19	18	17	16
MODE15[1:0]		MODE14[1:0]		MODE13[1:0]		MODE12[1:0]		MODE11[1:0]		MODE10[1:0]		MODE9[1:0]		MODE8[1:0]	
rw	rw	rw	rw	rw	rw	rw	rw	rw	rw	rw	rw	rw	rw	rw	rw
15	14	13	12	11	10	9	8	7	6	5	4	3	2	1	0
MODE7[1:0]		MODE6[1:0]		MODE5[1:0]		MODE4[1:0]		MODE3[1:0]		MODE2[1:0]		MODE1[1:0]		MODE0[1:0]	
rw	rw	rw	rw	rw	rw	rw	rw	rw	rw	rw	rw	rw	rw	rw	rw

Bits 31:0 **MODEy[1:0]**: Port x configuration I/O pin y (y = 15 to 0)
 These bits are written by software to configure the I/O mode.
 00: Input mode
 01: General purpose output mode
 10: Alternate function mode
 11: Analog mode (reset state)

GPIOx_ODR - address offset: 0x14

31	30	29	28	27	26	25	24	23	22	21	20	19	18	17	16
Res.	Res.	Res.	Res.	Res.	Res.	Res.	Res.	Res.	Res.	Res.	Res.	Res.	Res.	Res.	Res.
15	14	13	12	11	10	9	8	7	6	5	4	3	2	1	0
OD15	OD14	OD13	OD12	OD11	OD10	OD9	OD8	OD7	OD6	OD5	OD4	OD3	OD2	OD1	OD0
rw	rw	rw	rw	rw	rw	rw	rw	rw	rw	rw	rw	rw	rw	rw	rw

Bits 31:16 Reserved, must be kept at reset value.
 Bits 15:0 **ODy**: Port output data I/O pin y (y = 15 to 0)
 These bits can be read and written by software.

Bus	Secure boundary address	Nonsecure boundary address	Size (bytes)	Peripheral	Peripheral register map	STM32U535/545	STM32U575/585	STM32U59x/5Ax	STM32U5F/5Gx
AHB2 (cont'd)	0x5202 2400 - 0x5202 27FF	0x4202 2400 - 0x4202 27FF	1 K	GPIOJ	GPIO register map	-	-	X	X
	0x5202 2000 - 0x5202 23FF	0x4202 2000 - 0x4202 23FF	1 K	GPIOI		-	X	X	X
	0x5202 1C00 - 0x5202 1FFF	0x4202 1C00 - 0x4202 1FFF	1 K	GPIOH		X	X	X	X
	0x5202 1800 - 0x5202 1BFF	0x4202 1800 - 0x4202 1BFF	1 K	GPIOG		X	X	X	X
	0x5202 1400 - 0x5202 17FF	0x4202 1400 - 0x4202 17FF	1 K	GPIOF		-	X	X	X
	0x5202 1000 - 0x5202 13FF	0x4202 1000 - 0x4202 13FF	1 K	GPIOE		X	X	X	X
	0x5202 0C00 - 0x5202 0FFF	0x4202 0C00 - 0x4202 0FFF	1 K	GPIOD		X	X	X	X
	0x5202 0800 - 0x5202 0BFF	0x4202 0800 - 0x4202 0BFF	1 K	GPIOC		X	X	X	X
	0x5202 0400 - 0x5202 07FF	0x4202 0400 - 0x4202 07FF	1 K	GPIOB		X	X	X	X
	0x5202 0000 - 0x5202 03FF	0x4202 0000 - 0x4202 03FF	1 K	GPIOA		X	X	X	X

```

1 use core::ptr::{write_volatile, read_volatile};
2
3 const GPIOA_BASE_ADDR: usize = 0x4202_0000;
4 const GPIOA_MODER: *mut u32 =
5     GPIOA_BASE_ADDR as *mut u32;
6 const GPIOA_ODR: *mut u32 =
7     (GPIOA_BASE_ADDR + 0x14) as *mut u32;
8
9 unsafe {
10     let val = read_volatile(GPIOA_MODER);
11     let mask = !(0b11 << (2 * pin));
12     // `0b01` is General Purpose Output mode
13     let val = (val & mask) | (0b01 << (2 * pin));
14     write_volatile(GPIOA_MODER, val);
15     // set pin high
16     write_volatile(GPIOA_ODR, 1 << pin);
17 }
  
```



GPIO Input

GPIOx_MODER - address offset: 0x00

31	30	29	28	27	26	25	24	23	22	21	20	19	18	17	16
MODE15[1:0]		MODE14[1:0]		MODE13[1:0]		MODE12[1:0]		MODE11[1:0]		MODE10[1:0]		MODE9[1:0]		MODE8[1:0]	
rw	rw	rw	rw	rw	rw	rw	rw	rw	rw	rw	rw	rw	rw	rw	rw
15	14	13	12	11	10	9	8	7	6	5	4	3	2	1	0
MODE7[1:0]		MODE6[1:0]		MODE5[1:0]		MODE4[1:0]		MODE3[1:0]		MODE2[1:0]		MODE1[1:0]		MODE0[1:0]	
rw	rw	rw	rw	rw	rw	rw	rw	rw	rw	rw	rw	rw	rw	rw	rw

Bits 31:0 **MODEy[1:0]**: Port x configuration I/O pin y (y = 15 to 0)

These bits are written by software to configure the I/O mode.

00: Input mode

01: General purpose output mode

10: Alternate function mode

11: Analog mode (reset state)

GPIOx_PUPDR - address offset: 0x0C

31	30	29	28	27	26	25	24	23	22	21	20	19	18	17	16
PUPD15[1:0]		PUPD14[1:0]		PUPD13[1:0]		PUPD12[1:0]		PUPD11[1:0]		PUPD10[1:0]		PUPD9[1:0]		PUPD8[1:0]	
rw	rw	rw	rw	rw	rw	rw	rw	rw	rw	rw	rw	rw	rw	rw	rw
15	14	13	12	11	10	9	8	7	6	5	4	3	2	1	0
PUPD7[1:0]		PUPD6[1:0]		PUPD5[1:0]		PUPD4[1:0]		PUPD3[1:0]		PUPD2[1:0]		PUPD1[1:0]		PUPD0[1:0]	
rw	rw	rw	rw	rw	rw	rw	rw	rw	rw	rw	rw	rw	rw	rw	rw

Bits 31:0 **PUPDy[1:0]**: Port x configuration I/O pin y (y = 15 to 0)

These bits are written by software to configure the I/O pull-up or pull-down

00: No pull-up, pull-down

01: Pull-up

10: Pull-down

11: Reserved

GPIOx_IDR - address offset: 0x10

31	30	29	28	27	26	25	24	23	22	21	20	19	18	17	16
Res	Res	Res	Res	Res	Res	Res	Res	Res	Res	Res	Res	Res	Res	Res	Res
15	14	13	12	11	10	9	8	7	6	5	4	3	2	1	0
ID15	ID14	ID13	ID12	ID11	ID10	ID9	ID8	ID7	ID6	ID5	ID4	ID3	ID2	ID1	ID0
r	r	r	r	r	r	r	r	r	r	r	r	r	r	r	r

Bits 31:16 **Reserved**, must be kept at reset value.

Bits 15:0 **IDy**: Port x input data I/O pin y (y = 15 to 0)

These bits are read-only. They contain the input value of the corresponding I/O port.

```

1 use core::ptr::{write_volatile, read_volatile};
2
3 const GPIOC_BASE_ADDR: usize = 0x4202_0800;
4 const GPIOC_MODER: *mut u32 =
5     GPIOC_BASE_ADDR as *mut u32;
6 const GPIOC_PUPDR: *mut u32 =
7     (GPIOC_BASE_ADDR + 0x0C) as *mut u32;
8 const GPIOC_IDR: *mut u32 =
9     (GPIOC_BASE_ADDR + 0x10) as *mut u32;
10
11 unsafe {
12     let val = read_volatile(GPIOC_MODER);
13     let val = val & !(0b11 << (2 * pin));
14     // configure pin as input
15     write_volatile(GPIOC_MODER, val);
16
17     let val = read_volatile(GPIOC_PUPDR);
18     let mask = !(0b11 << (2 * pin));
19     let val = (val & mask) | (0b10 << (2 * pin));
20     // configure pull down (0b10)
21     write_volatile(GPIOC_PUPDR, val);
22
23     // read pin value
24     let value = read_volatile(GPIOC_IDR);
25     let pin_val = (value & (1 << pin)) != 0;
26 }

```

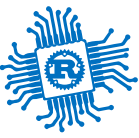

Input

read the value from pin `x` of port `y`

- enable the Port clock signal
- configure the pin as input by setting the pin's bits of the respective port's Mode Register, `GPIOy_MODER`, to `0b10`.
- read the `x` bit of the `GPIOy_IDR` register.
- *adjust the `GPIOy_PUPDR` fields to set the pull up/down resistor*

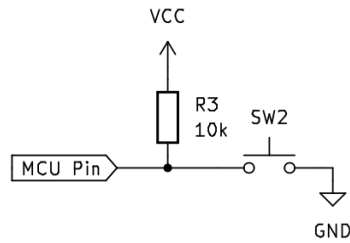

Output

write a value to pin `x` of port `y`

- enable the Port clock signal
- configure the pin as output by setting the pin's bits of the respective port's Mode Register, `GPIOy_MODER`, to `0b10`.
- set the `x` bit of the `GPIOy_ODR` register.
- *adjust the Port `y` registers to set the speed and configuration*

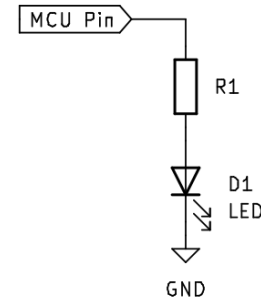

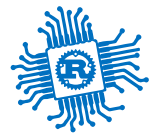

Rust Embedded HAL

The Rust API for embedded systems

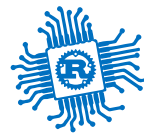

The Rust Embedded Stack

Framework	Tasks, Memory Management, Network etc. <code>embassy</code> , <code>rtic</code>
BSC	Board Support Crate <code>embassy-rp</code> , <code>rp-pico</code> , <code>embassy-stm32</code>
<i>HAL Implementation</i>	Uses the PAC and exports a standard HAL towards the upper levels <code>embassy-stm32</code>
PAC	Accesses registers, usually created automatically from SVD files - <code>rp-pac</code> , <code>stm32-metapac</code>

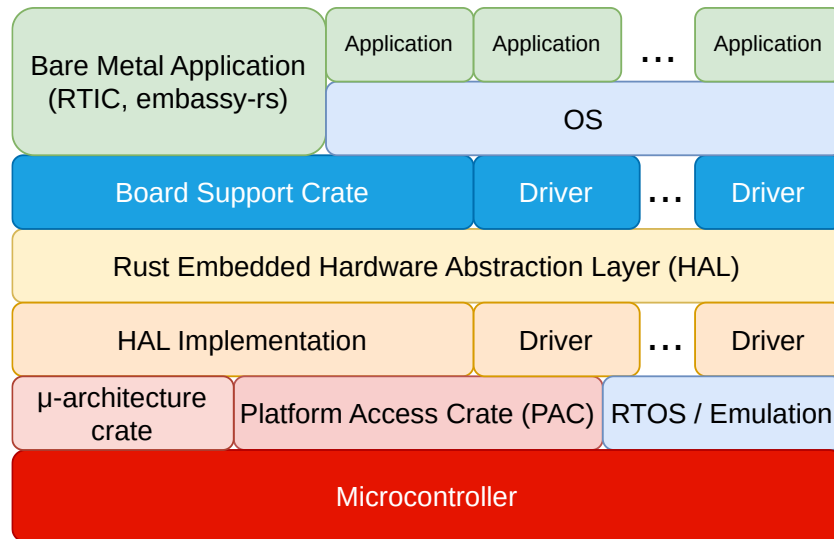



GPIO HAL

A set of standard traits

All devices should implement these traits for GPIO.

```
1 pub enum PinState {
2     Low,
3     High,
4 }
```

Input

```
pub trait InputPin: ErrorType {
    // Required methods
    fn is_high(&mut self) -> Result<bool, Self::Error>;
    fn is_low(&mut self) -> Result<bool, Self::Error>;
}
```

Output

```
pub trait OutputPin: ErrorType {
    // Required methods
    fn set_low(&mut self) -> Result<(), Self::Error>;
    fn set_high(&mut self) -> Result<(), Self::Error>;

    // Provided method
    fn set_state(
        &mut self,
        state: PinState
    ) -> Result<(), Self::Error> { ... }
}
```



Bare metal

This is how a Rust application would look like

```
1  #![no_std]
2  #![no_main]
3
4  use cortex_m_rt::entry;
5  use core::panic::PanicInfo;
6
7  #[entry]
8  fn main() -> ! {
9      // your code goes here
10
11     loop { }
12 }
13
14 #[panic_handler]
15 pub fn panic(_info: &PanicInfo) -> ! {
16     loop { }
17 }
```

Rules

1. never exit the `main` function
2. add a panic handler that does not exit

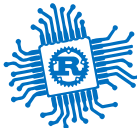

Bare metal without PAC & HAL

This is how a Rust application would look like on the RP2

```
1  #[no_std]
2  #[no_main]
3
4  use core::ptr::{read_volatile, write_volatile};
5  use cortex_m_rt::entry;
6  use core::panic::PanicInfo;
7
8  const PIN: u32 = ...; // 0 to 20
9
10 const GPIOX_CTRL: u32 = 0x4001_4004;
11 const GPIO_OE_SET: *mut u32 = 0xd000_0024 as *mut u32;
12 const GPIO_OUT_SET: *mut u32 = 0xd000_0014 as *mut u32;
13 const GPIO_OUT_CLR: *mut u32 = 0xd000_0018 as *mut u32;
14
15 #[panic_handler]
16 pub fn panic(_info: &PanicInfo) -> ! {
17     loop { }
18 }
```

```
18  #[entry]
19  fn main() -> ! {
20
21     /* setup the clocks */
22
23     let gpio_ctrl = (GPIOX_CTRL + 8 * PIN) as *mut u32;
24     unsafe {
25         write_volatile(gpio_ctrl, 5);
26         write_volatile(GPIO_OE_SET, 1 << PIN);
27         let reg = match value {
28             0 => GPIO_OUT_CLR,
29             _ => GPIO_OUT_SET
30         };
31         write_volatile(reg, 1 << PIN);
32     };
33
34     loop { }
35 }
```

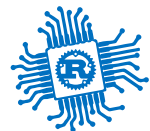

Bare metal without PAC & HAL

This is how a Rust application would look like on the STM32U545RE

```
1  #![no_std]
2  #![no_main]
3
4  use core::ptr::{read_volatile, write_volatile};
5  use cortex_m_rt::entry;
6  use core::panic::PanicInfo;
7
8  const PORT_x: u32 = ...; // A is 0, B is 1, ...
9  const PIN: u32 = ...; // Ranging from 0 to 15
10
11 const GPIOx_BASE_ADDR: usize =
12     0x4202_0000 + 0x400 * PORT_x;
13 const GPIOx_MODER: *mut u32 =
14     GPIOx_BASE_ADDR as *mut u32;
15 const GPIOx_ODR: *mut u32 =
16     (GPIOx_BASE_ADDR + 0x14) as *mut u32;
17 const RCC_BASE_ADDR: usize = 0x4602_0C00;
18 const RCC_AHB2ENR1: *mut u32 =
19     (RCC_BASE_ADDR + 0x8C) as *mut u32;
```

```
20  #[panic_handler]
21  pub fn panic(_info: &PanicInfo) -> ! { loop { } }
22
23  #[cortex_m_rt::entry]
24  fn main() -> ! {
25     /* setup the clocks */
26     unsafe {
27         let mut val = read_volatile(RCC_AHB2ENR1);
28         let val = val | (1 << PORT_x);
29         write_volatile(RCC_AHB2ENR1, val);
30     }
31
32     unsafe {
33         let val = read_volatile(GPIOx_MODER);
34         let mask = !(0b11 << (2 * PIN));
35         let val = (val & mask) | (0b01 << (2 * PIN));
36         write_volatile(GPIOx_MODER, val);
37         write_volatile(GPIOx_ODR, 1 << PIN);
38     }
39
40     loop { }
41 }
```

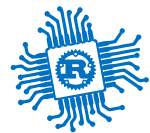

embassy

Embedded Asynchronous



embassy-rs

- framework
- uses the rust-embedded-hal
- Features
 - Real-time
 - Low power
 - Networking
 - Bluetooth
 - USB
 - Bootloader and DFU



GPIO Input

RP2

```
1  #![no_std]
2  #![no_main]
3
4  use embassy_executor::Spawner;
5  use embassy_rp::gpio;
6  use gpio::{Input, Pull};
7
8  #[embassy_executor::main]
9  async fn main(_spawner: Spawner) {
10     let p = embassy_rp::init(Default::default());
11     let pin = Input::new(p.PIN_3, Pull::Up);
12
13     if pin.is_high() {
14
15     } else {
16
17     }
18 }
```

STM32U545RE

```
1  #![no_std]
2  #![no_main]
3
4  use embassy_executor::Spawner;
5  use embassy_stm32::gpio;
6  use gpio::{Input, Pull};
7
8  #[embassy_executor::main]
9  async fn main(_spawner: Spawner) {
10     let p = embassy_stm32::init(Default::default());
11     let pin = Input::new(p.PC13, Pull::Down);
12
13     if pin.is_high() {
14
15     } else {
16
17     }
18 }
```

The `main` function is called by the `embassy` framework, so it can return.

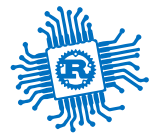

GPIO Input for RP2 vs STM32U545RE

```
1 // STM32U545RE
2
3 #![no_std]
4 #![no_main]
5
6 use embassy_executor::Spawner;
7 use embassy_stm32::gpio;
8 use gpio::{Input, Pull};
9
10 #[embassy_executor::main]
11 async fn main(_spawner: Spawner) {
12     let p = embassy_stm32::init(Default::default());
13     let pin = Input::new(p.PC13, Pull::Down);
14
15     if pin.is_high() {
16
17     } else {
18
19     }
20 }
```

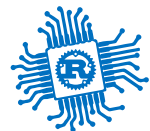

GPIO Output

RP2

```
1  #![no_std]
2  #![no_main]
3
4  use embassy_executor::Spawner;
5  use embassy_rp::gpio;
6  use gpio::{Level, Output};
7
8  #[embassy_executor::main]
9  async fn main(_spawner: Spawner) {
10     let p = embassy_rp::init(Default::default());
11     let mut pin = Output::new(p.PIN_2, Level::Low);
12
13     pin.set_high();
14 }
```

STM32U545RE

```
1  #![no_std]
2  #![no_main]
3
4  use embassy_executor::Spawner;
5  use embassy_stm32::gpio;
6  use gpio::{Level, Output, Speed};
7
8  #[embassy_executor::main]
9  async fn main(_spawner: Spawner) {
10     let p = embassy_stm32::init(Default::default());
11     let mut pin = Output::new(
12         p.PA5,
13         Level::Low,
14         Speed::Medium
15     );
16
17     pin.set_high();
18 }
```

The `main` function is called by the `embassy` framework, so it can return.



GPIO Output for RP2 vs STM32U545RE

```
1 // STM32U545RE
2
3 #![no_std]
4 #![no_main]
5
6 use embassy_executor::Spawner;
7 use embassy_stm32::gpio;
8 use gpio::{Level, Output, Speed};
9
10 #[embassy_executor::main]
11 async fn main(_spawner: Spawner) {
12     let p = embassy_stm32::init(Default::default());
13     let mut pin = Output::new(p.PA5, Level::Low, Speed::Medium);
14
15     pin.set_high();
16 }
```

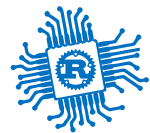

Conclusion

we talked about

- Memory Mapped IO
- RP2040 GPIO
 - Single Cycle IO
 - IO Bank
 - Pad
- STM32U545RE
 - GPIO
 - Port MODER
 - Port Setup
- The Rust embedded standard stack
- Bare metal Rust
- The embassy-rs framework